

IFP92UW

IFP105 Series

Commercial Touch Display

User Guide

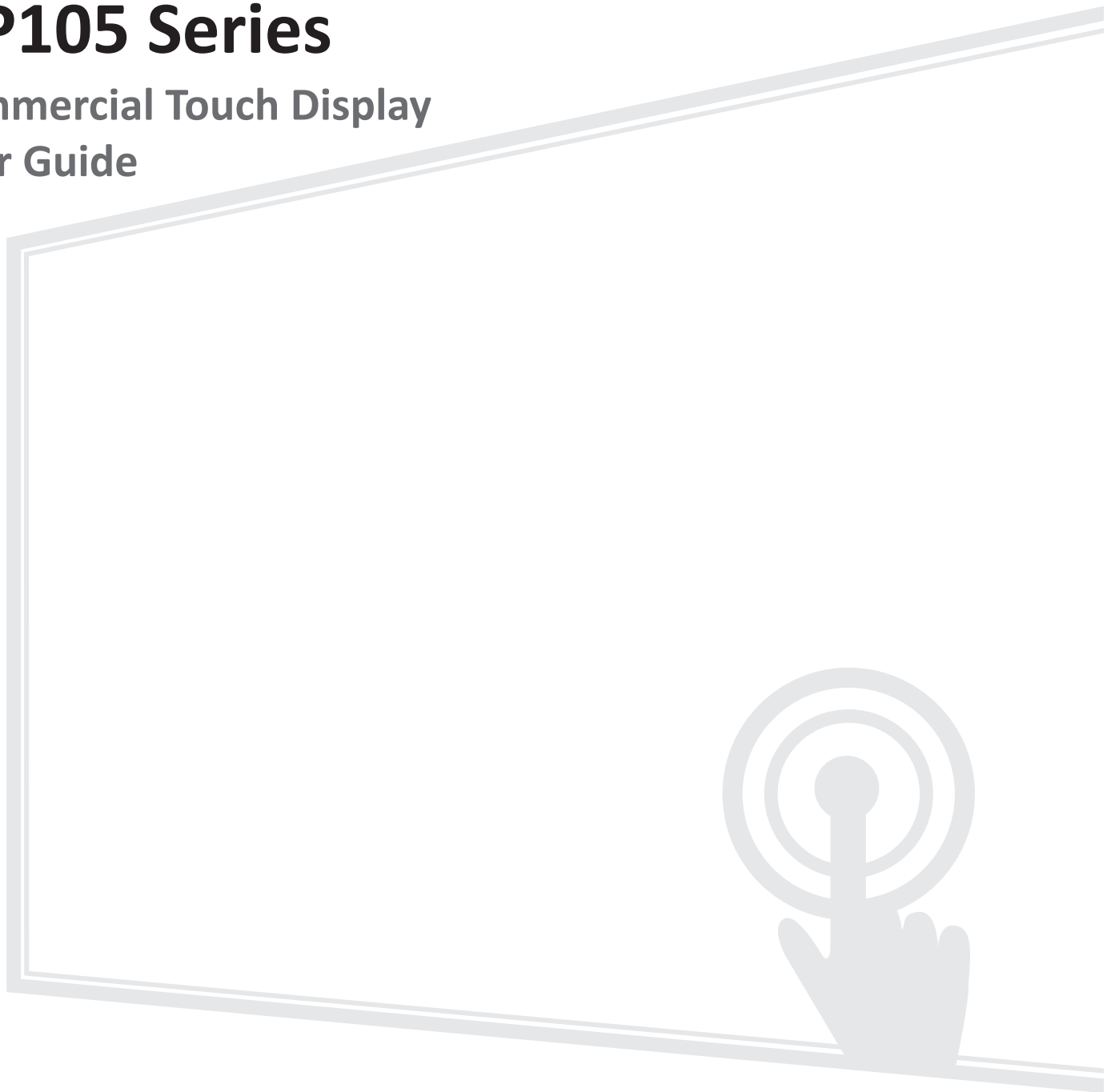

IMPORTANT: Please read this User Guide to obtain important information on installing and using your product in a safe manner, as well as registering your product for future service. Warranty information contained in this User Guide will describe your limited coverage from ViewSonic® Corporation, which is also found on our web site at <http://www.viewsonic.com> in English, or in specific languages using the Regional selection box of our website.

Thank you for choosing ViewSonic®

As a world-leading provider of visual solutions, ViewSonic® is dedicated to exceeding the world's expectations for technological evolution, innovation, and simplicity. At ViewSonic®, we believe that our products have the potential to make a positive impact in the world, and we are confident that the ViewSonic® product you have chosen will serve you well.

Once again, thank you for choosing ViewSonic®!

Safety Precautions

Please read the following **Safety Precautions** before you start using the device.

- Keep this user guide in a safe place for later reference.
- Read all warnings and follow all instructions.
- Do not use the device near water. To reduce the risk of fire or electric shock, do not expose the device to moisture.
- Never remove the rear cover. This display contains high-voltage parts. You may be seriously injured if you touch them.
- Avoid exposing the device to direct sunlight or other sources of sustained heat.
- Do not install near any heat sources such as radiators, heat registers, stoves, or other devices (including amplifiers) that may increase the temperature of the device to dangerous levels.
- Use a soft, dry cloth to clean the external housing. For more information, refer to the "Maintenance" section.
- When moving the device, be careful not to drop or bump the device on anything.
- Do not place the device on an uneven or unstable surface. The device may fall over resulting in an injury or a malfunction.
- Do not place any heavy objects on the device or connection cables.
- If smoke, an abnormal noise, or a strange odor is present, immediately turn the device off and call your dealer or ViewSonic®. It is dangerous to continue using the device.
- The device is a monitor with an LED backlight intended for general office use.
- Do not attempt to circumvent the safety provisions of the polarized or grounding-type plug. A polarized plug has two blades with one wider than the other. A grounding-type plug has two blades and a third grounding prong. The wide blade and the third prong are provided for your safety. If the plug does not fit into your outlet, obtain an adapter and do not attempt to force the plug into the outlet.
- When connecting to a power outlet, DO NOT remove the grounding prong. Please ensure grounding prongs are NEVER REMOVED.
- Protect the power cord from being treaded upon or pinched, particularly at the plug, and at the point where it emerges from the equipment. Ensure that the power outlet is located near the equipment so that it is easily accessible.

- Only use attachments/accessories specified by the manufacturer.
- When a cart is used, use with caution when moving the cart/equipment combination to avoid injury from tipping over.
- Disconnect the power plug from the AC outlet if the device is not being used for a long period of time.
- Place the device in a well-ventilated area. Do not place anything on the device that prevents heat dissipation.

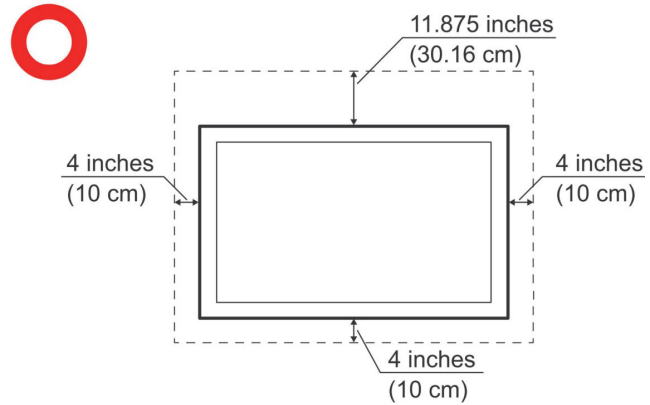
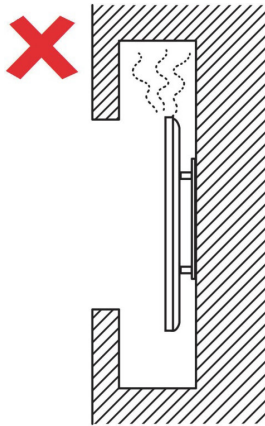

Caution:

Immediately unplug your device from the wall outlet and refer servicing to a qualified service personnel under the following conditions:

- When the power supply cord or plug is damaged.
- If liquid has been spilled onto or objects have fallen into the unit.
- If the unit has been exposed to moisture.
- If the unit does not operate normally or has been dropped.

Never place the device in an unstable location. The device may fall, causing serious personal injury or death. Many injuries, particularly to children, can be avoided by taking simple precautions such as:

- Using cabinets or stands recommended by the manufacturer of the device.
- Only using furniture that can safely support the device.
- Ensuring the device is not overhanging the edge of the supporting furniture.
- Not placing the device on tall furniture (e.g., cupboards or bookcases) without anchoring both the furniture and the device to a suitable support.
- Not placing the device on cloth or other materials that may be located between the device and supporting furniture.
- Educating children about the dangers of climbing on furniture to reach the device or its controls.

If the existing device is going to be retained and relocated, the same considerations as above should be applied.

Contents

Safety Precautions.....	3
Introduction	11
Package Contents	11
IFP92UW.....	11
IFP105UW/IFP105UW-N	12
IFP105S/IFP105G	13
Wall Mount Kit Specifications (VESA)	14
IFP92UW.....	14
IFP105S/IFP105G/IFP105UW/IFP105UW-N	15
Product Overview	16
Control Panel and Front I/O	17
I/O Panel.....	18
Remote Control	20
Using Gestures	24
Making Connections	26
Connecting to Power	26
Connecting to External Devices and Enabling Touch.....	27
DisplayPort Connection.....	28
HDMI Connection	28
USB Type C Connection	28
RS-232 Connection	29
USB Connection	30
USB Type A	30
USB Type C	30
Network Connection.....	31
Media Connection	32
Audio Connection	33
Audio In	33
Audio Out	33
SPDIF Connection	33
Video Output Connection (HDMI Out)	34
Optional Connections	35
Slot-in PC (OPS Slot) Installation	35
Wi-Fi Card (Wi-Fi Slot) Installation	36
UMB202 Camera Plate Installation	37

Using the ViewBoard	38
Turning On/Off the ViewBoard.....	38
Initial Launch Setup	39
Home Screen	41
How to Sign Up.....	41
Use as Guest.....	42
Sign In.....	42
Home Screen Message	43
Toolbar	44
Toolbar Icons.....	45
Applications	46
Tools	47
Control Bar	48
Control Bar Icons.....	48
On-Screen Display (OSD) Menu - General Settings	49
Input Source	50
Display.....	52
Low Blue Light Filter and Eye Health.....	54

System Settings	56
Network & Internet	56
Wi-Fi	57
Ethernet	58
Wireless Hotspot	59
Display	63
Wallpaper	64
Protection.....	65
HDMI Out	66
Preferences.....	67
Touch.....	68
Language	68
Keyboard & Input Method	69
Date & Time	70
Boot Mode & Advanced Settings	71
Startup & Shutdown.....	73
Toolbar Settings	75
Multi-Window Mode.....	75
Sound Setting	75
Input Source	76
Label Input Source.....	77
Source	78
Apps.....	79
Apps	80
System	82
Storage	83
Clone to USB.....	84
Display ID.....	85
Security.....	86
System Update	88
About Device	89

Pre-installed Applications and Settings.....	90
myViewBoard	90
Screen Recorder	93
vCast	94
Display Group Settings	96
Synchronized Group Screen All the Time	98
Share a Screen to the Display Group (One to Many Casting).....	98
Moderator Mode	99
Broadcast	100
Multiple Screen Sharing	100
Preview Screen.....	100
Touch.....	100
Casting from Windows, MacBook, and Chrome Devices	101
Casting from Android Devices	103
Casting from Apple iOS Devices	106
Connecting to a ViewBoard from a Mobile Device	109
Casting with Chromecast.....	110
Casting with Miracast.....	112
Other Default Applications	114
Browser	114
Finder	115
Office.....	116
PIP (Picture-in-Picture).....	117
Visualizer	119
vSweeper.....	120
RS-232 Protocol.....	121
Description	121
RS-232 Hardware Specification	121
LAN Hardware Specification.....	122
RS232 Communication Setting.....	122
LAN Communication Setting	122
Command Message Reference.....	122
Protocol	123
Set-Function Listing.....	123
Get-Function Listing	129
Remote Control Pass-through Mode	137

Appendix.....	140
Display Modes	140
HDMI 1 & DisplayPort Mode	140
HDMI 2/3/4 & Type C Mode.....	141
Troubleshooting	142
Maintenance.....	144
General Precautions.....	144
Cleaning the Screen.....	144
Cleaning the Case	144
Regulatory and Service Information	145
Compliance Information.....	145
FCC Compliance Statement.....	145
Industry Canada Statement.....	145
CE Conformity for European Countries	145
Declaration of RoHS2 Compliance.....	146
ENERGY STAR Statement.....	147
Indian Restriction of Hazardous Substances	148
Product Disposal at End of Product Life	148
Copyright Information	149
Customer Service	150
Limited Warranty	151
Mexico Limited Warranty.....	154

Introduction

Package Contents

IFP92UW

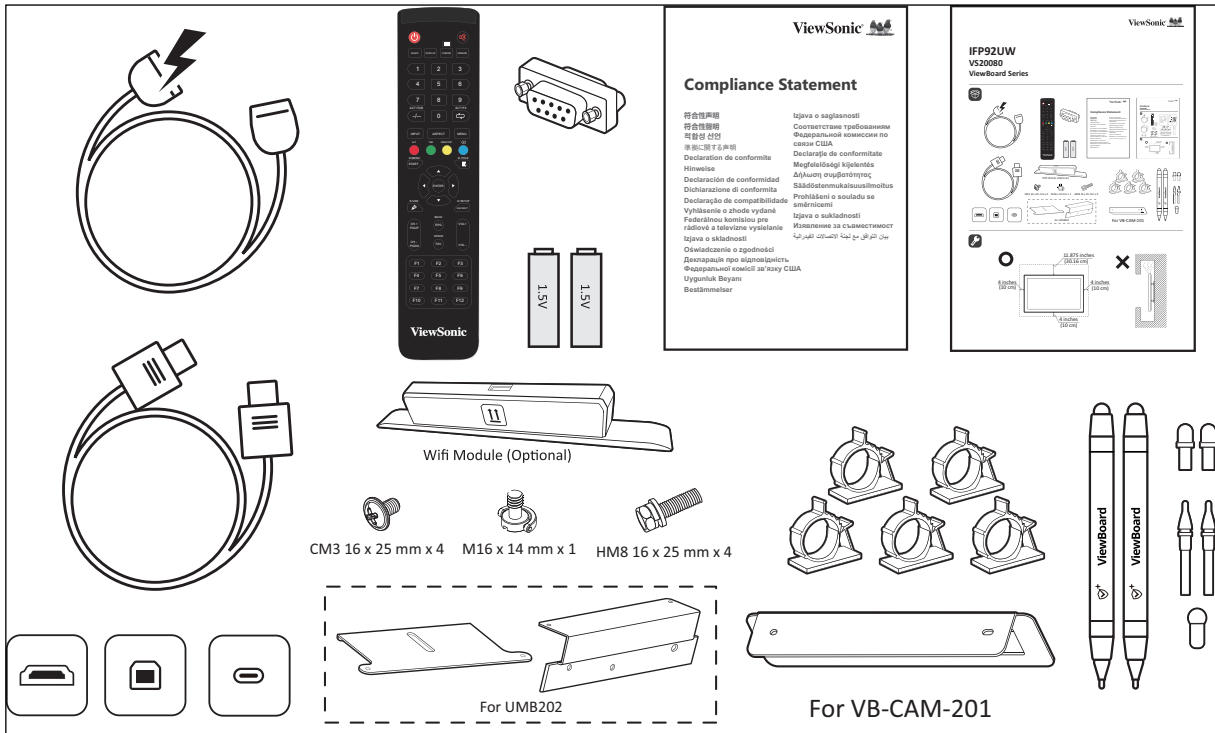

- HDMI Cable (3 m)
- Power Cable (by region)
- Remote Control
- AAA Battery
- USB Touch Cable (3 m)
- 2 x Touch Pen
- 3 x Replacement Pen Nib
- RS-232 Adapter
- 5 x Clamp
- 2 x Camera Plate
- 9 x Screw
- Quick Start Guide
- Compliance Statement
- USB Type C Cable

NOTE: The cables included in your package may vary depending on your country. Please contact your local reseller for more information.

IFP105UW/IFP105UW-N

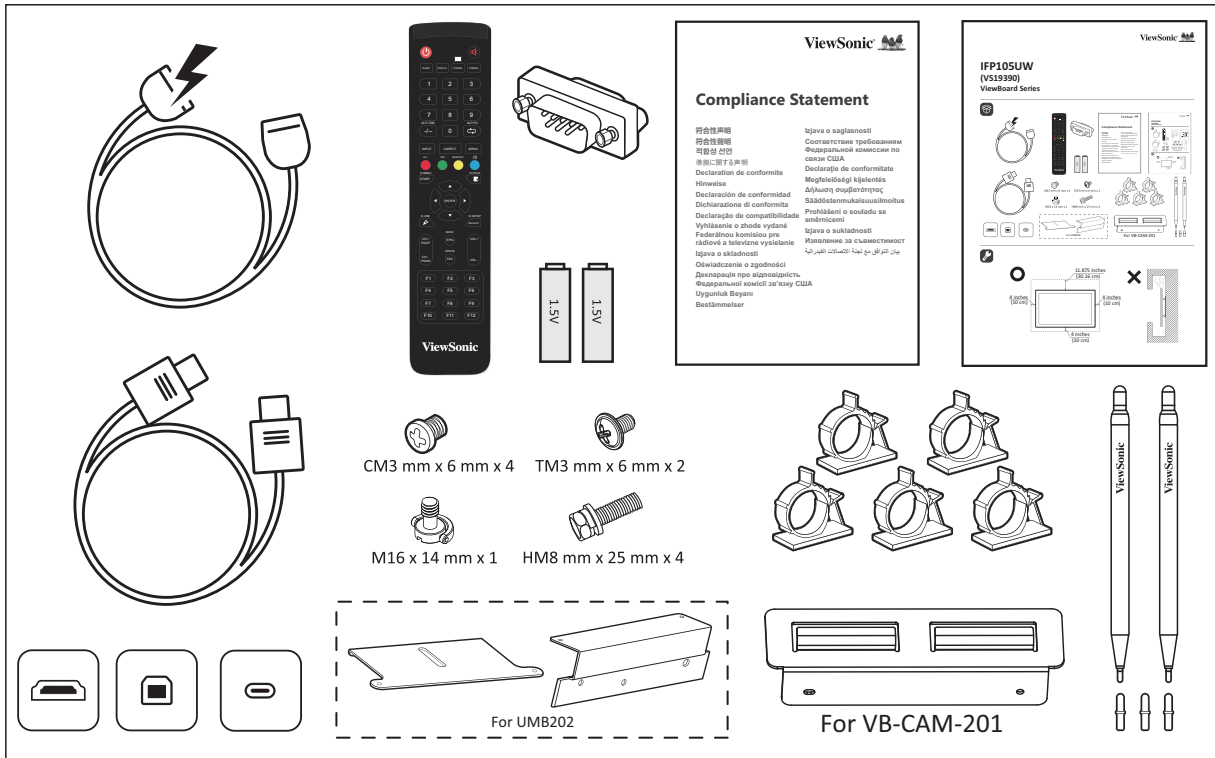

- HDMI Cable (3 m)
- Power Cable (by region)
- Remote Control
- AAA Battery
- USB Touch Cable (3 m)
- 2 x Touch Pen
- 3 x Replacement Pen Nib
- RS-232 Adapter
- 5 x Clamp
- 2 x Camera Plate
- 11 x Screw
- Quick Start Guide
- Compliance Statement
- USB Type C Cable

NOTE: The cables included in your package may vary depending on your country. Please contact your local reseller for more information.

IFP105S/IFP105G

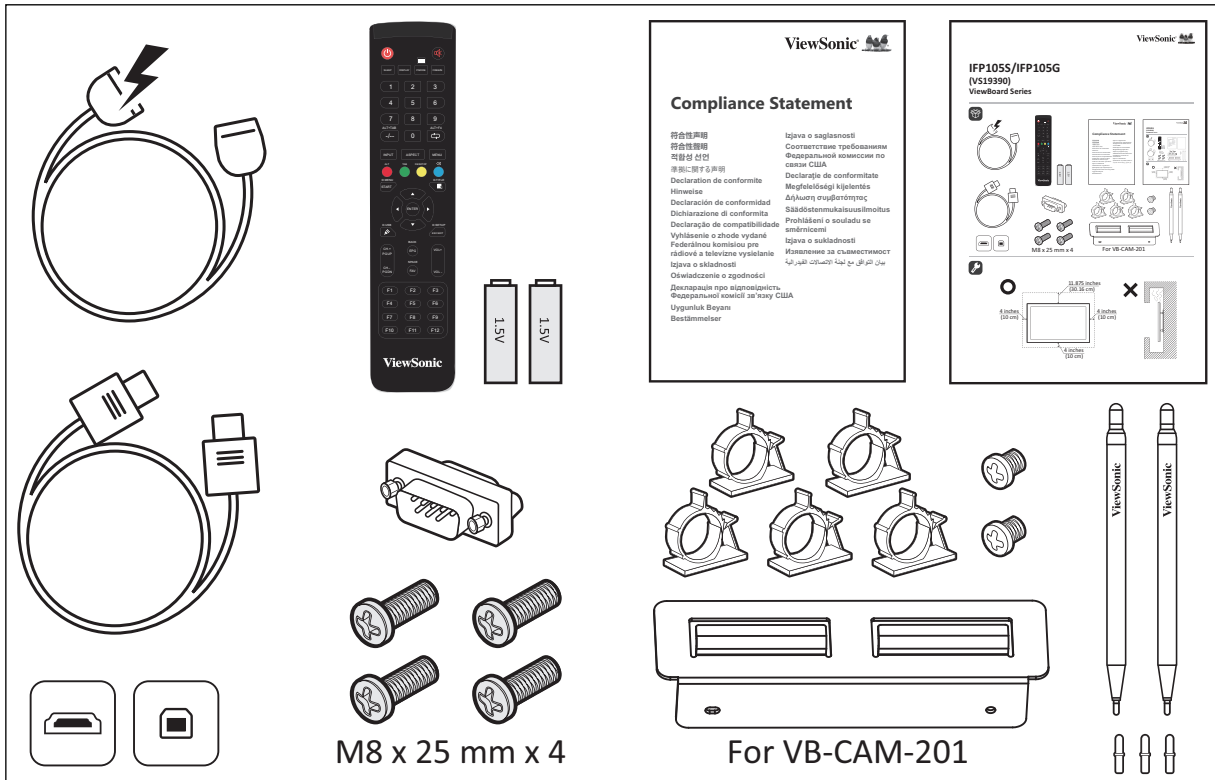

- HDMI Cable (3 m)
- Power Cable (by region)
- Remote Control
- AAA Battery
- USB Touch Cable (3 m)
- 2 x Touch Pen
- 3 x Replacement Pen Nib
- RS-232 Adapter
- 5 x Clamp
- 1 x Camera Plate
- 6 x Screw
- Quick Start Guide
- Compliance Statement

NOTE: The cables included in your package may vary depending on your country. Please contact your local reseller for more information.

Wall Mount Kit Specifications (VESA)

IFP92UW

NOTE: Please follow the instructions in the wall mount installation guide to install your wall mount or mobile mount bracket. If attaching to other building materials, please contact your nearest dealer.

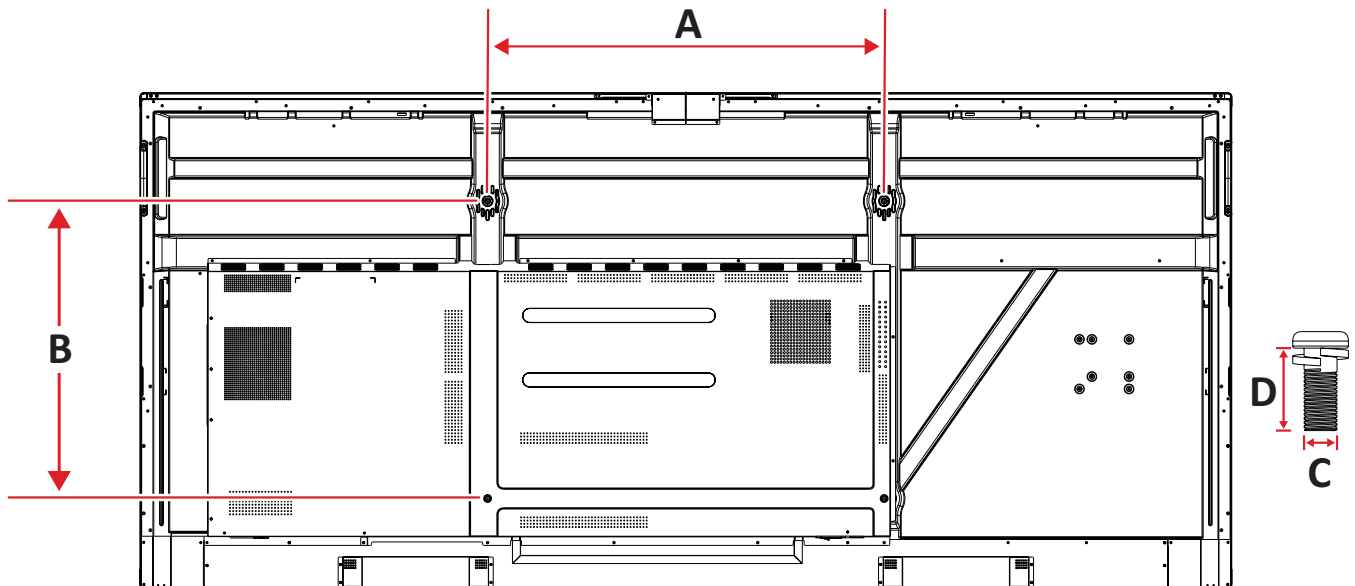

Model	VESA Spec. (A x B)	Standard Screw (C x D)	Quantity
IFP92UW	800 x 600 mm	M8 x 25 mm	4

NOTE: Do not use screws that are longer than the standard dimension, as they may cause damage to the inside of the display.

IFP105S/IFP105G/IFP105UW/IFP105UW-N

NOTE: Please follow the instructions in the wall mount installation guide to install your wall mount or mobile mount bracket. If attaching to other building materials, please contact your nearest dealer.

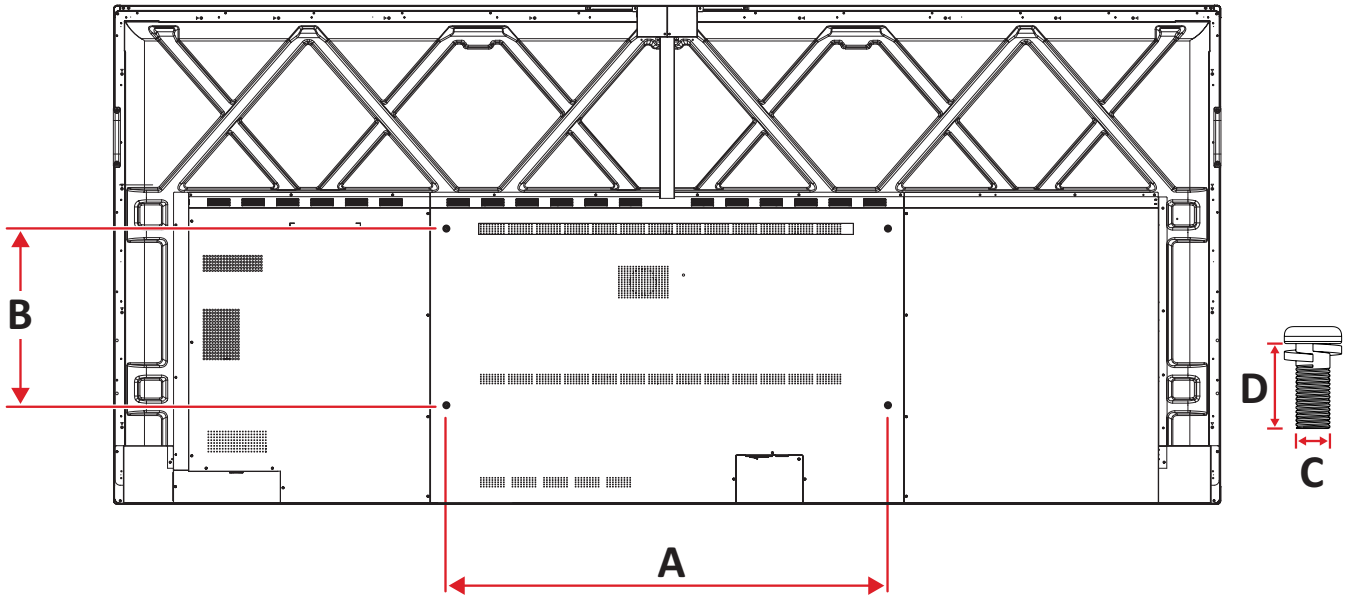

Model	VESA Spec. (A x B)	Standard Screw (C x D)	Quantity
IFP105S IFP105G IFP105UW IFP105UW-N	1000 x 400 mm	M8 x 25 mm	4

NOTE: Do not use screws that are longer than the standard dimension, as they may cause damage to the inside of the display.

Product Overview

Front Panel





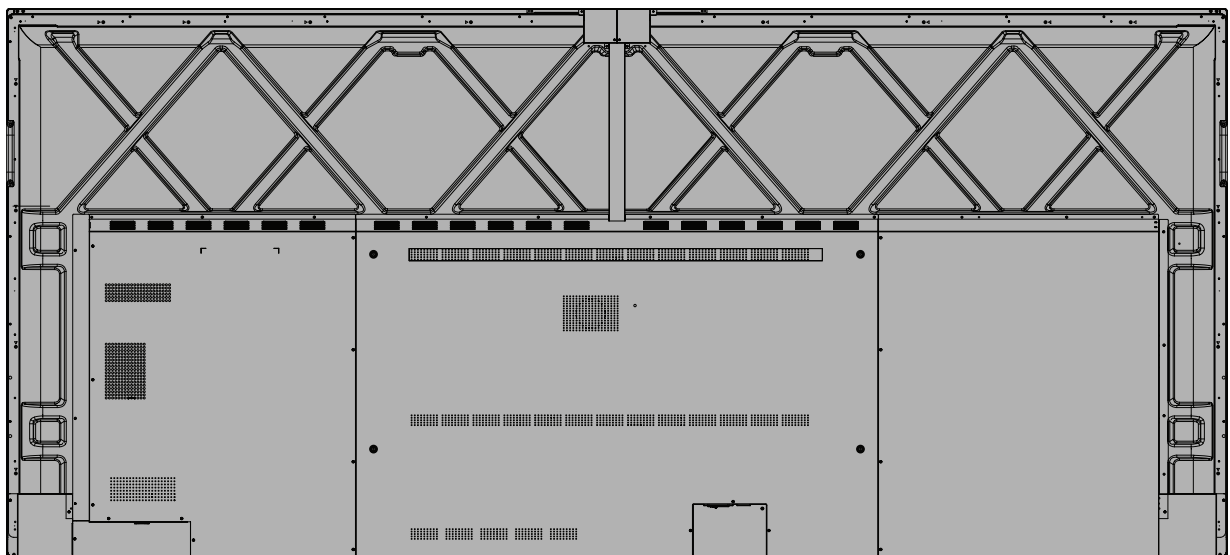

Control Panel and Front I/O

Rear Panel

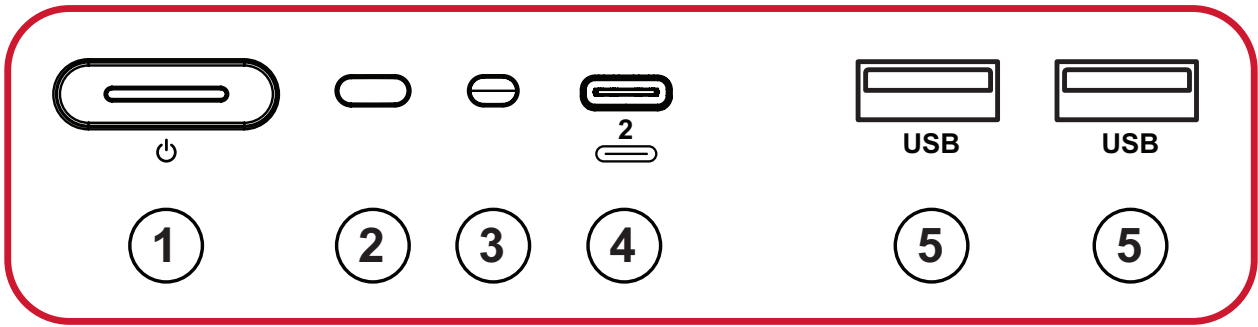

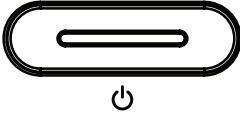
Control Panel and Front I/O



Number	Item	Description
1		<ul style="list-style-type: none"> • Power indicator light. • Press to turn ON the device. • Press to turn OFF/ON the display backlight only. • Press and hold to turn off the device.
2		Remote Control receiver.
3		Ambient Light Sensor to monitor the ambient light.
4		<ul style="list-style-type: none"> • USB Type C Power Delivery (15W, 5.0V~3.0A) • Connect to a PC with USB Type C output.
5		<ul style="list-style-type: none"> • USB Type A input • Connect USB devices such as hard disks, keyboard, mouse, etc. • Automatically switches between PC and external PC.

I/O Panel

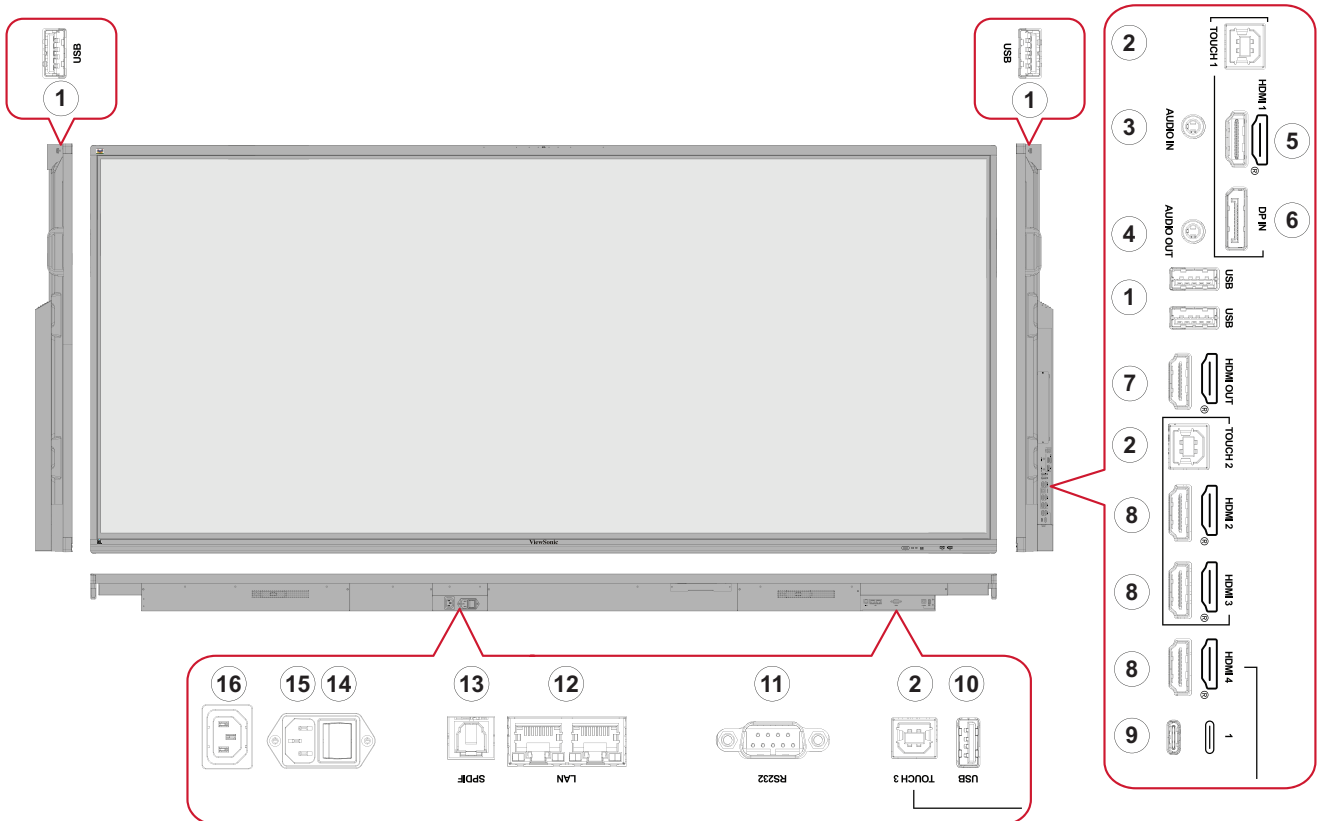

Figure 1

Number	Item	Description
1	USB 3.0	<ul style="list-style-type: none"> • USB Type A input • Connect USB devices such as hard disks, keyboard, mouse, etc. • Automatically switches between PC and external PC.
2	TOUCH 1/2/3	Touch signal output to external PC NOTE: <ul style="list-style-type: none"> • TOUCH 1 supports HDMI 1 and DP IN. • TOUCH 2 supports HDMI 2 and HDMI 3. • TOUCH 3 supports HDMI 4.
3	AUDIO IN	External computer audio input.
4	AUDIO OUT	Audio out to an external speaker.
5	HDMI 1	<ul style="list-style-type: none"> • 5K high-definition input. • Connect to a PC with HDMI output, set-top box, or other video device.
6	DP IN	<ul style="list-style-type: none"> • DisplayPort Input • Connect to a PC or other video device with DisplayPort output.
7	HDMI OUT	Extend content out to another display device.

Number	Item	Description
8	HDMI 2/3/4	<ul style="list-style-type: none"> High-definition input. Connect to a PC with HDMI output, set-top box, or other video device.
9	USB Type C	<ul style="list-style-type: none"> USB Type C Power Delivery (65W, 20.0V~3.25A) DP 1.2 with USB 3.0 return 10M/100M Ethernet
10	USB 2.0	<ul style="list-style-type: none"> USB Type A input For firmware update.
11	RS-232	<ul style="list-style-type: none"> Serial interface For mutual transfer of data between devices.
12	LAN	<ul style="list-style-type: none"> Standard RJ45 (10M/100M/1G) internet For ViewBoard and Slot-in PC use.
13	SPDIF	SPDIF output.
14	Power Switch	Turn ON/OFF AC power supply.
15	AC IN	AC power input.
16	AC OUT	AC power output.

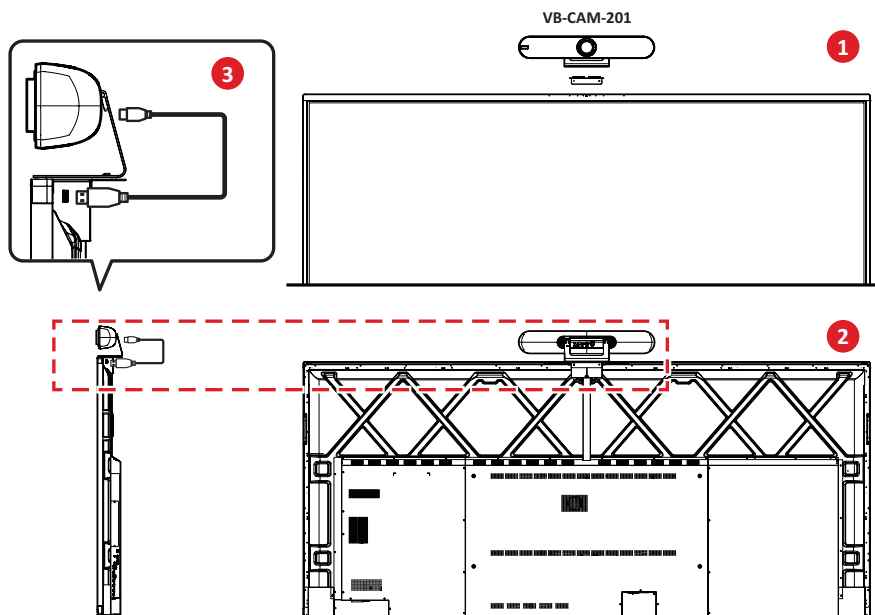
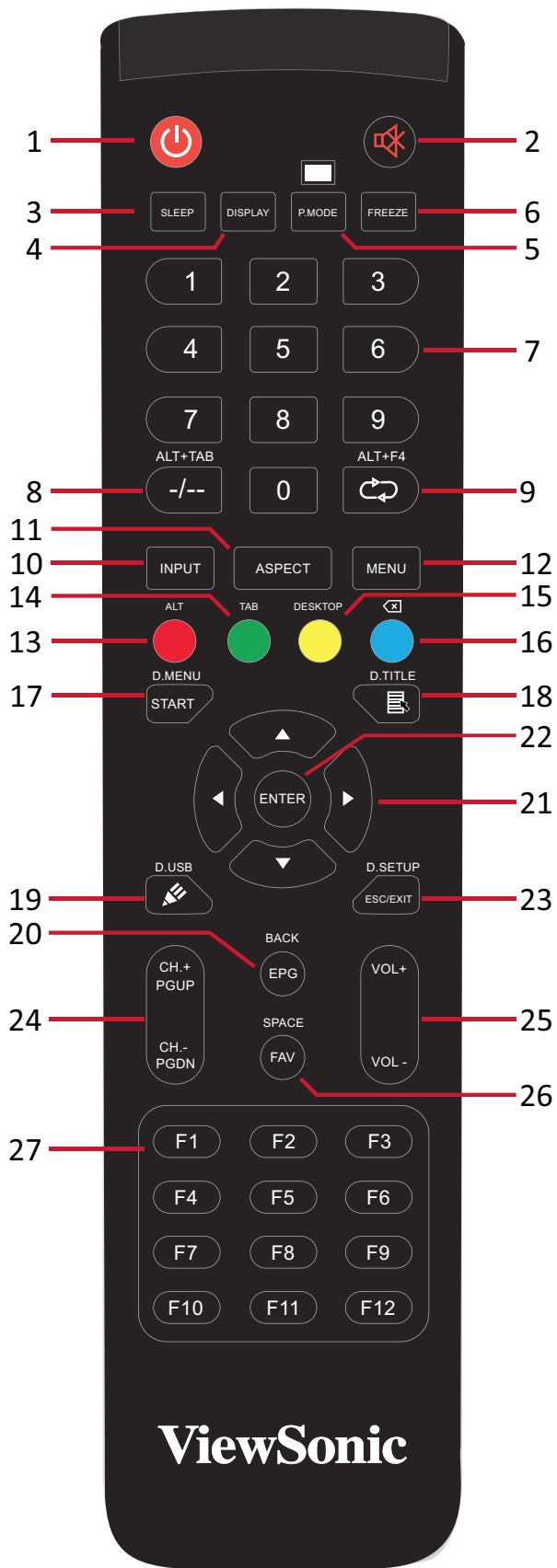











Figure 2

NOTE:

- **Figure 1** - There are two, a numbered (1 2) and unnumbered (≡), versions of the USB Type C port icon label on the Control Panel and I/O for this product line. Both versions' USB Type C ports function the same.
- **Figure 2** - For the best viewing angle, it is recommended to install the USB camera on top of the ViewBoard and connect the camera to the upper USB port.

Remote Control



Number	Item	Description
1		Power ON/OFF
2		Mute/Unmute
3	SLEEP	Sleep Mode
4	DISPLAY	For Non-Android sources; display current input source information
5	P.MODE	Blank Screen
6	FREEZE	Freeze Screen
7		Numeric input buttons
8	ALT+TAB -/--	Slot-in computer space bar Alt+Tab
9	ALT+F4 	Slot-in computer, close program window
10	INPUT	Input source selection
11	ASPECT	Back to slot-in system main interface
12	MENU	For Android, access Settings; for other sources, access Touch Menu settings
13	Red / ALT	Screen capture
14	Green / TAB	PC ¹ [Tab] button
15	Yellow / DESKTOP	Switch to slot-in PC desktop
16	BLUE/ 	PC ¹ [Backspace] button
17	START / D.MENU	PC ¹ [Windows] button
18	 / D.TITLE	PC ¹ [Menu] button
19	 / D.USB	Writing software setup
20	EPG/BACK	Return button
21	 /  /  / 	Scroll up, down, left, and right
22	ENTER	Confirm selection/state
23	ESC / EXIT / D.SETUP	Shortcut button to exit dialogue boxes
24	CH.+ / PGUP / CH.- / PGDN	CH+: PC previous page CH-: PC next page
25	VOL+ / VOL-	Increase/Decrease volume
26	FAV / SPACE	PC ¹ [Space] button
27	F1-F12	Built-in computer F1 - F12 function button

¹ All computer-related function keys are not available without a slot-in computer.

Inserting Remote Control Batteries

To insert batteries into the remote control:

1. Remove the cover on the rear of the remote control.
2. Insert two “AAA” batteries, ensuring the “+” symbol on the battery matches the “+” on the battery post.
3. Replace the cover by aligning it with the slot on the remote control and snapping the latch shut.

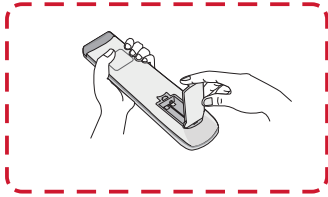

(1)

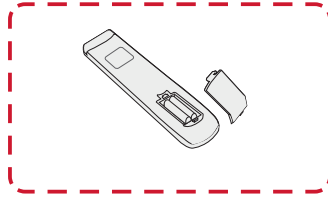

(2)

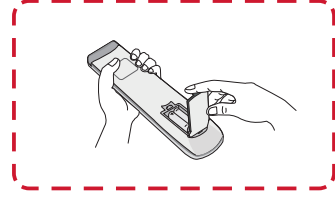

(3)

WARNING: There is a risk of explosion if batteries are replaced with the incorrect type.

NOTE:

- It is recommended that you do not mix battery types.
- Always dispose of old batteries in an environmentally friendly way. Contact your local government for more information on how to dispose of batteries safely.

Remote Control Receiver Range

The working range of the remote control is shown here. It has an effective range of 8 meters, 30° degrees left and right. Ensure there is nothing obstructing the remote control's signal to the receiver.



Using Gestures

Touch gestures allow the user to use pre-determined commands without using a keyboard or mouse. Using gestures on the ViewBoard, the user can select/deselect objects, change the location of an object, access settings, erase digital ink, and much more.

Select and Deselect an Object (Clicking)

Press and release the ViewBoard to select/deselect options or objects. This is like a single, standard left mouse click.

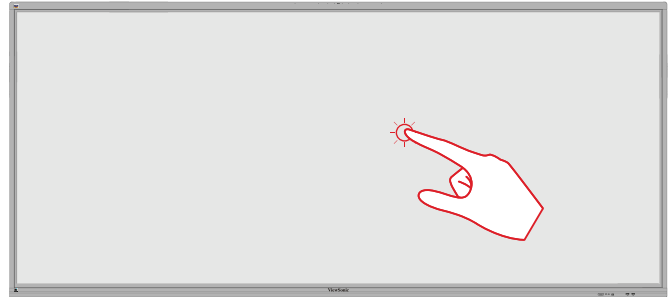

Display Menu Options (Right-Clicking)

Press and hold the ViewBoard with your finger. This is like a single, standard right mouse click.

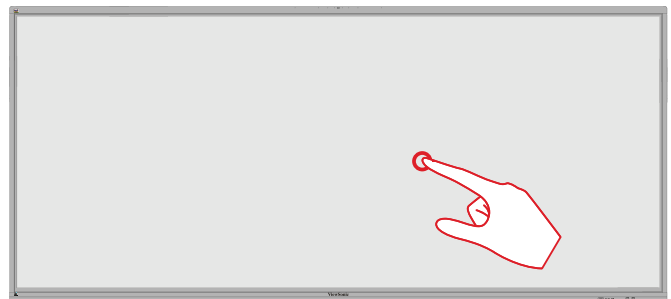

Double-Clicking

Quickly press and release twice in the same location on the ViewBoard. This is like a double, standard left mouse click.

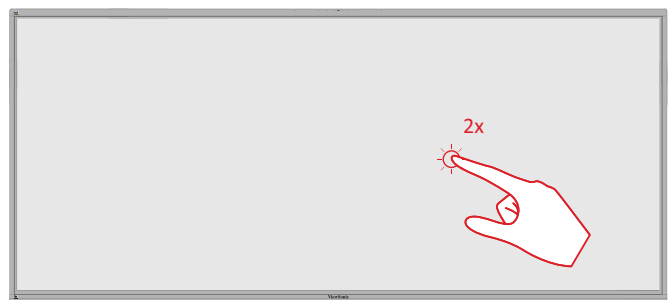

Moving an Object

Press and hold the object on the ViewBoard and slowly drag it with your finger to your desired location.

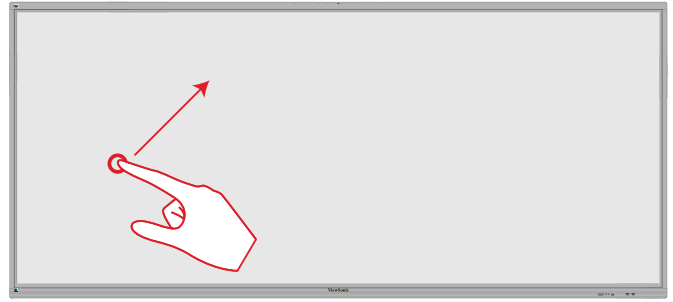

Erasing Digital Ink

Use your flattened hand, palm, or fist on the ViewBoard and move your hand across the area which you wish to erase.

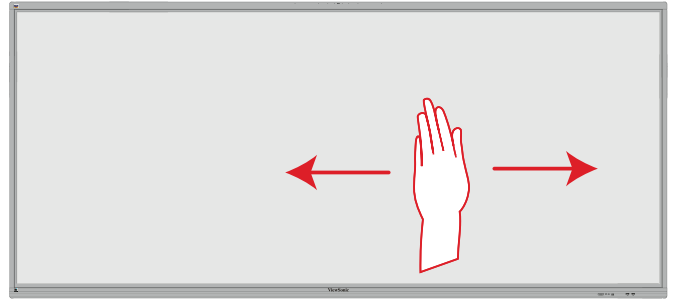

Swipe Up for General Settings

Swipe up from the bottom of the ViewBoard to launch the General Settings.

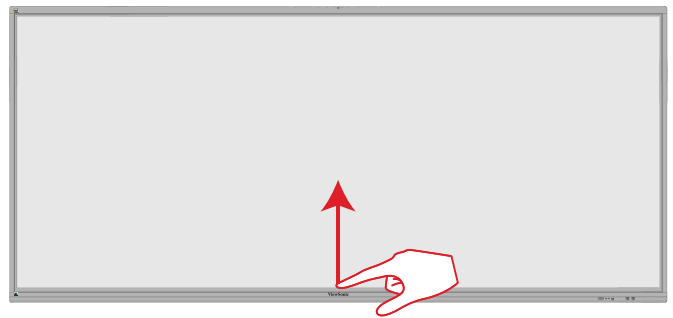

Making Connections

Connecting to Power

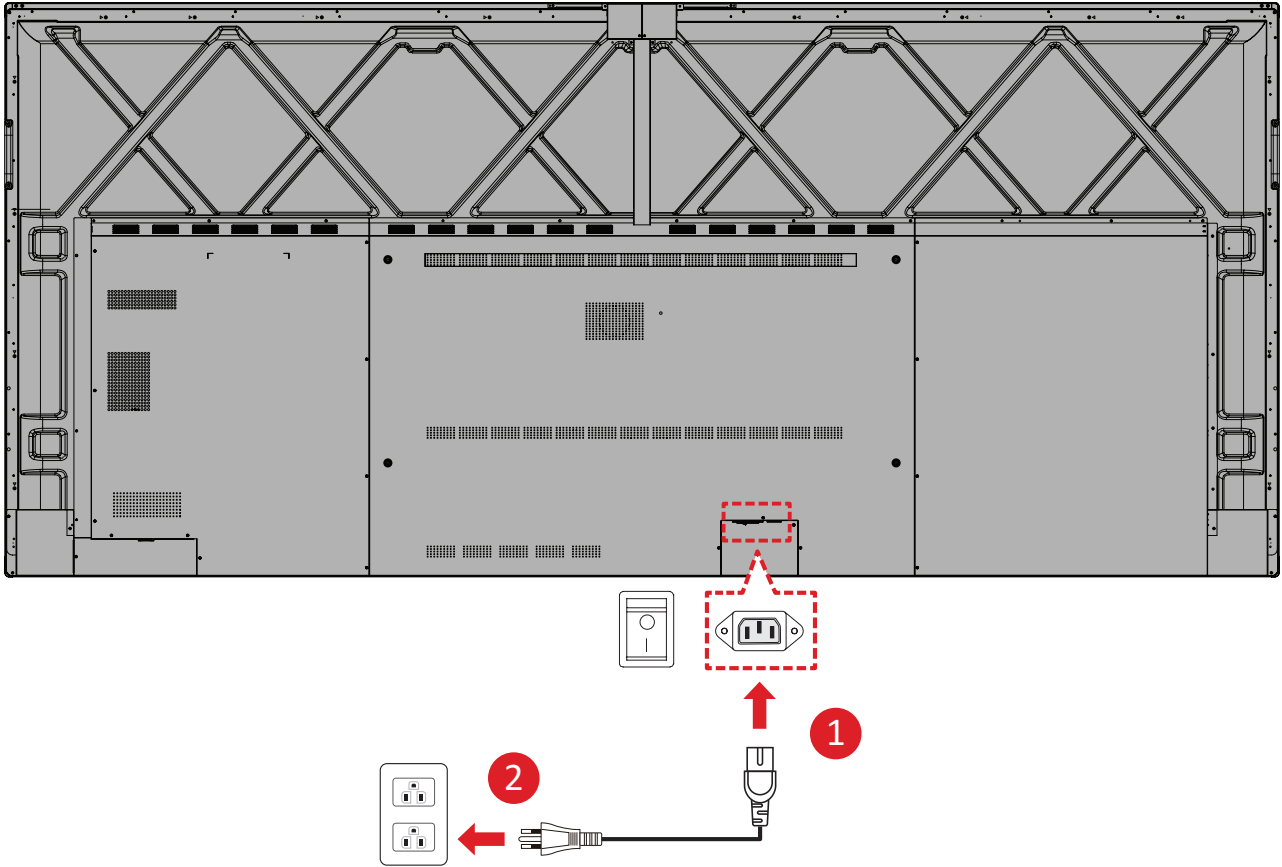

1. Connect the power cord to the AC IN jack at the rear of the display.
2. Plug the power cord plug into a power outlet.

Connecting to External Devices and Enabling Touch

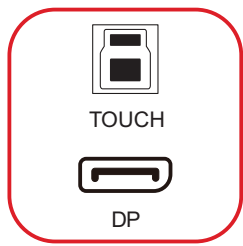

or

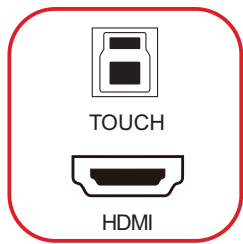

or

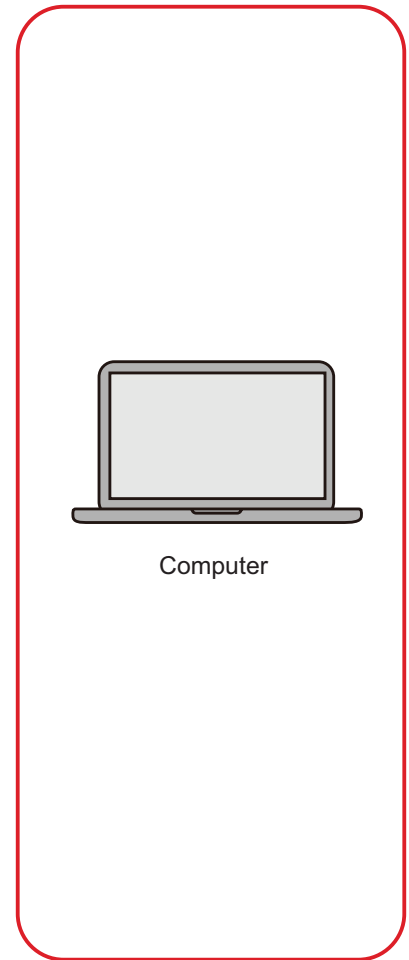
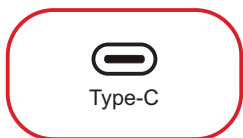

Your external device(s) can be connected in any of the following configurations:

DisplayPort Connection

To connect via DisplayPort:

1. Connect a DisplayPort cable from your external device to the **DP IN** port on the ViewBoard.
2. Connect a USB Type B to A cable to the external device from the **TOUCH 1** port of the ViewBoard.

NOTE: The **TOUCH 1** port is for the **HDMI 1** and **DP** ports. The **TOUCH 2** port is for the **HDMI 2** and **HDMI 3** ports. The **TOUCH 3** port is for the **HDMI 4** port.

HDMI Connection

To connect via HDMI:

1. Connect an HDMI cable from your external device to the **HDMI 1/HDMI 2/HDMI 3/HDMI 4** port on the ViewBoard.
2. Connect a USB Type B to A to the external device from the appropriate **TOUCH** port of the ViewBoard.

NOTE: The **TOUCH 1** port is for the **HDMI 1** and **DP** ports. The **TOUCH 2** port is for the **HDMI 2** and **HDMI 3** ports. The **TOUCH 3** port is for the **HDMI 4** port.

USB Type C Connection

To connect via Type C:

Connect a Type C cable from your external device to a **Type C** port on the ViewBoard.

RS-232 Connection



When you use a RS-232 serial cable to connect the display to an external computer or control system, certain functions can be controlled remotely such as: power on and off, volume adjustment, input select, brightness, and more.

USB Connection

Just like any PC, it is easy to connect various USB devices and other peripherals to your ViewBoard.

USB Type A

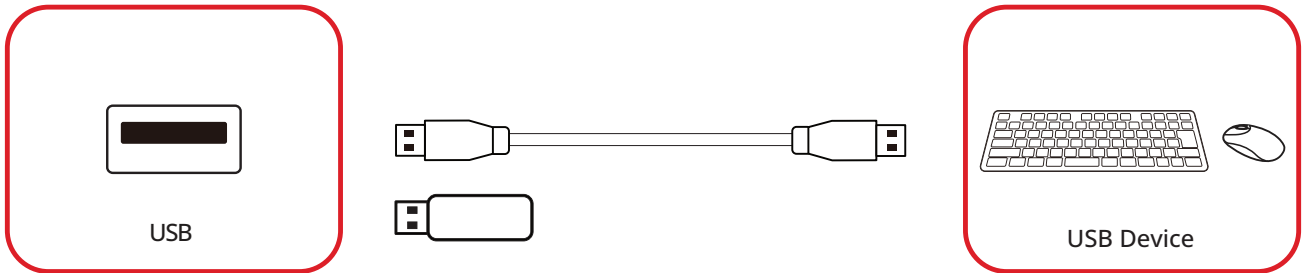

Plug the USB device or storage drive into a USB Type A port of the ViewBoard.

USB Type C

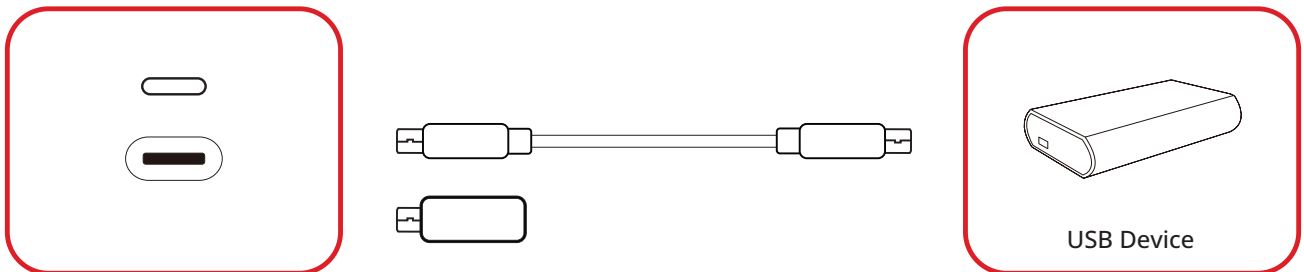

Plug the USB device or storage drive into the USB Type C port of the ViewBoard.

Network Connection



To connect to a local network, connect an Ethernet cable to your network, then connect the other end to a **LAN** port of the ViewBoard.

Media Connection

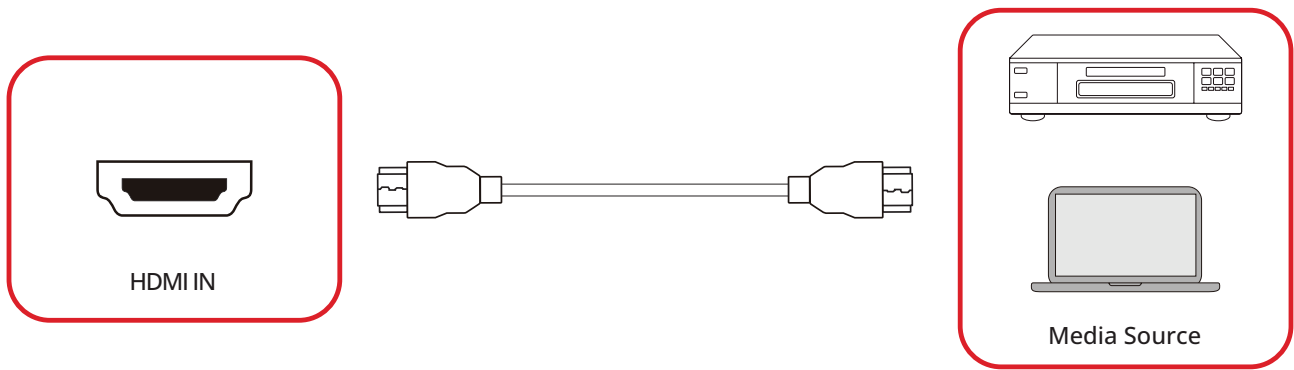

To connect to a media source:

1. Connect an HDMI cable to a **HDMI** port on your ViewBoard and peripheral device.
2. Plug in the power cord of your ViewBoard, and turn on the power supply switch.
3. Press the **Power** button on the ViewBoard to turn the screen on.
4. Press the **INPUT** button on the remote control and switch to the HDMI input source.

Audio Connection

The ViewBoard supports **Audio In**, **Audio Out**, and **SPDIF**.

Audio In

To play audio from your external device through the ViewBoard's speakers, connect one end of an audio cable to your external device, and the other end to the ViewBoard's **AUDIO IN** port.

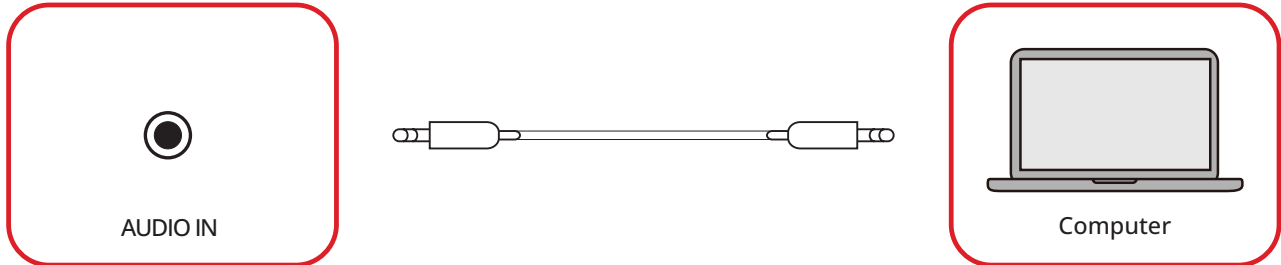

Audio Out

To play audio from the display through an external speaker, connect one end of an audio cable to the external speaker, and the other end to the ViewBoard's **Audio Out** port.

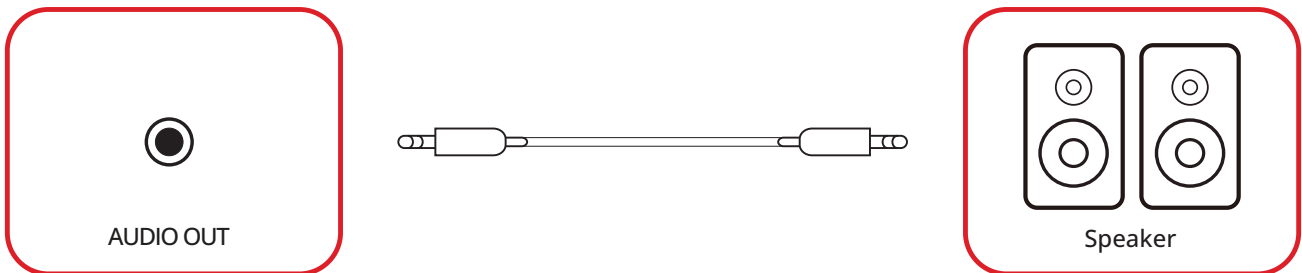

SPDIF Connection

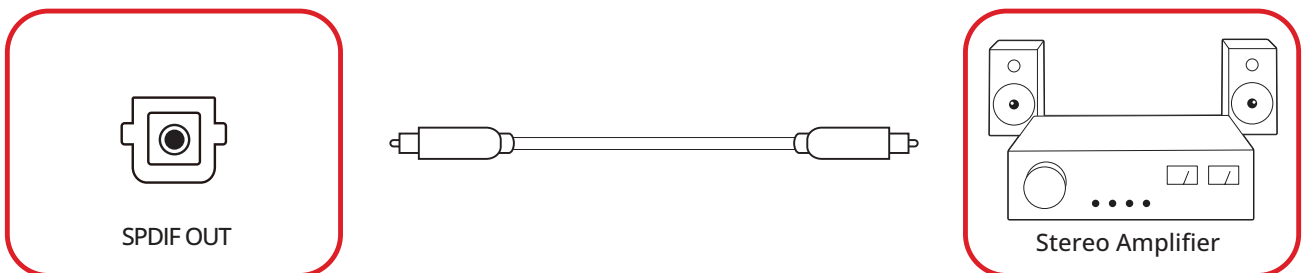

To connect to an external sound system:

1. Connect an optical cable from the **SPDIF** port to your sound system's optical connector.
2. Plug in the power cord of your ViewBoard, and turn on the power supply switch.
3. Press the **Power** button on the ViewBoard to turn the screen on.

Video Output Connection (HDMI Out)



To output video via a display device:

1. Connect an HDMI cable to the **HDMI IN** port of your display device, and the other end to the **HDMI OUT** port of the ViewBoard.
2. Plug in the power cord of the ViewBoard, and turn on the power supply switch.
3. Press the **Power** button on the ViewBoard to turn the screen on.
4. Press the **INPUT** button on the remote control and switch to the HDMI IN input source.

Optional Connections

The ViewBoard comes with an **OPS Slot** as well as a **Wi-Fi Slot** for optional add-ons such as a slot-in PC (e.g., VPC3X Series/VPCF5) or Wi-Fi card (e.g., VB-WIFI-004).

Slot-in PC (OPS Slot) Installation

1. Remove the **OPS Slot** cover of the display.

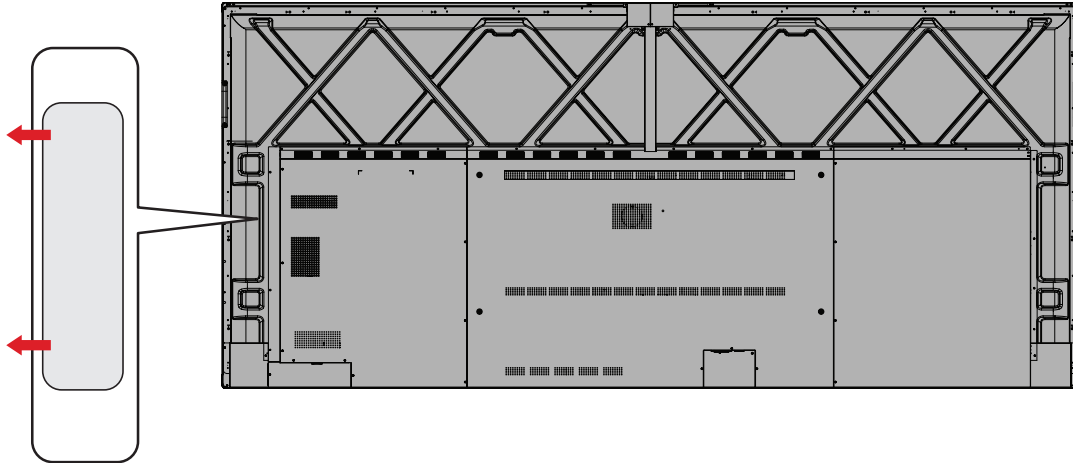

2. Carefully insert the slot-in PC into the **OPS Slot** of the display.

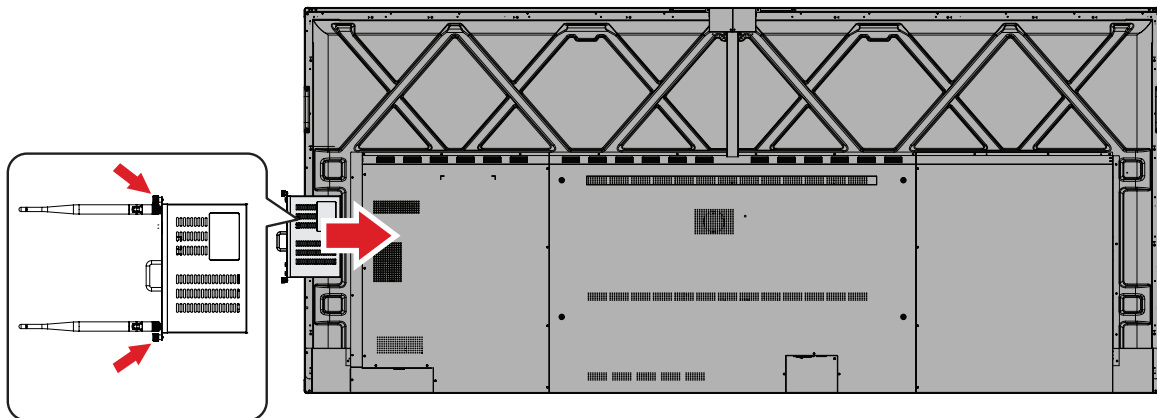

3. Secure the slot-in PC to the display.

Wi-Fi Card (Wi-Fi Slot) Installation

1. Remove the **Wi-Fi Slot** cover of the display.

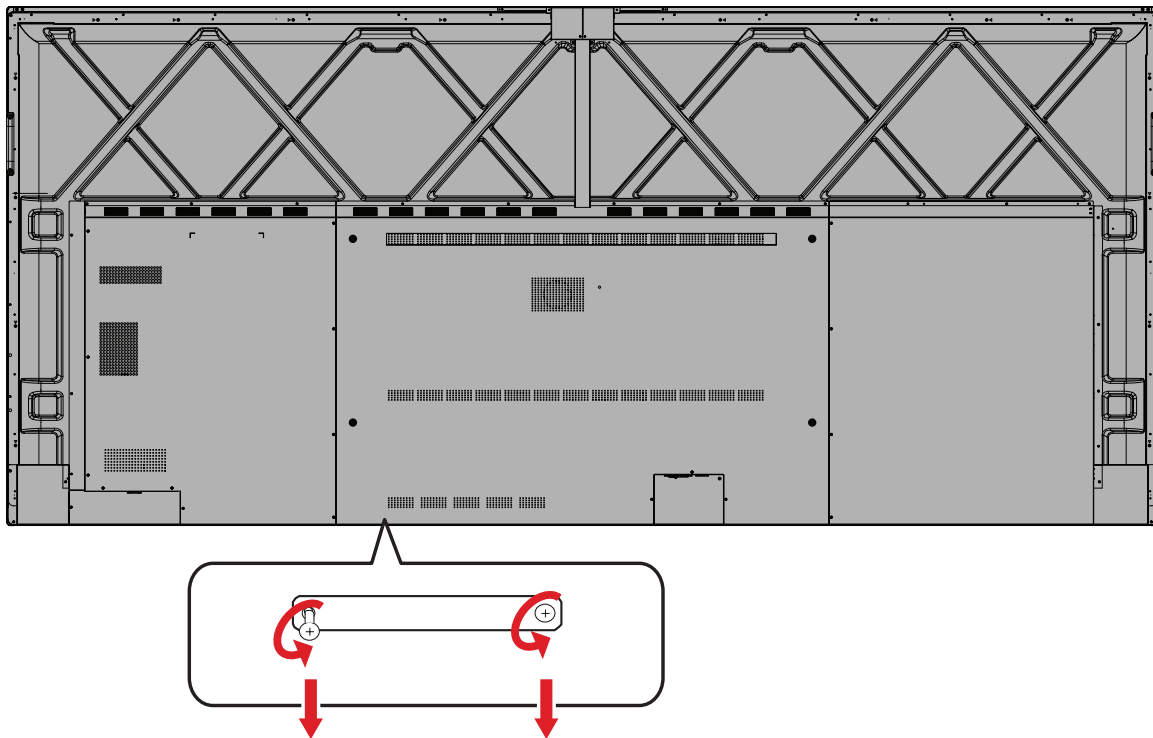

2. Carefully insert the slot-in Wi-Fi card into the **Wi-Fi Slot** of the display.

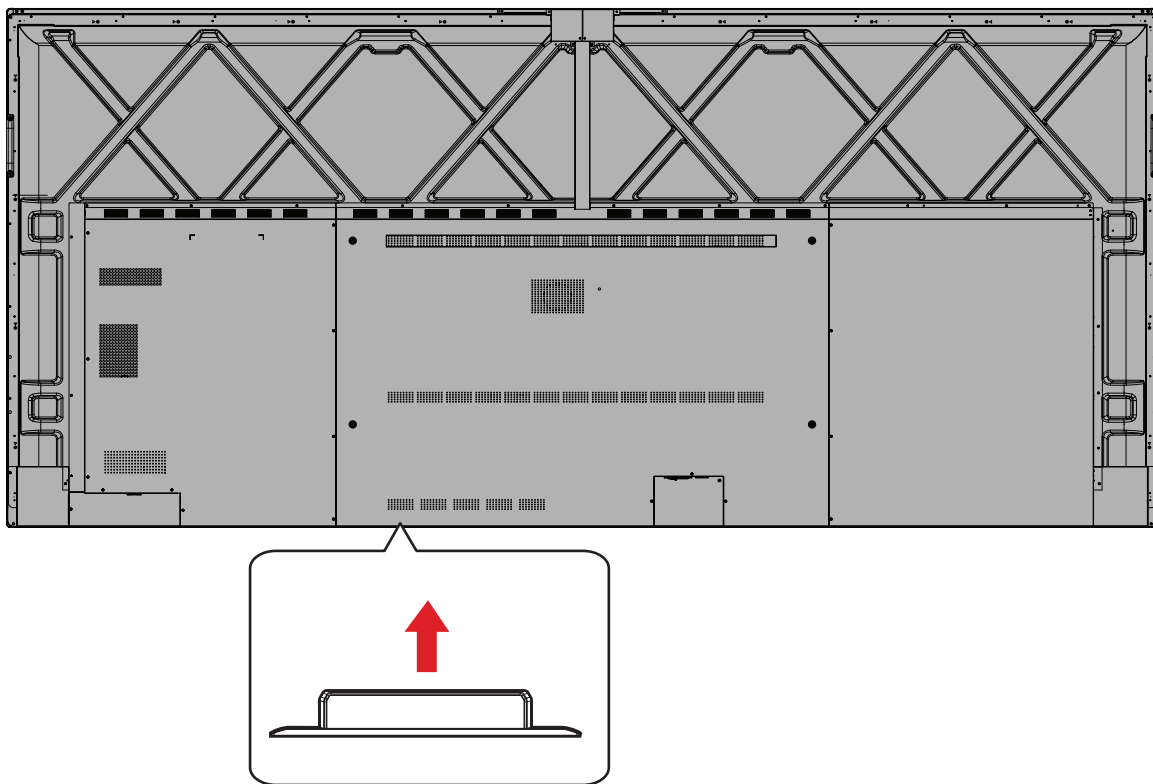

3. Secure the slot-in Wi-Fi card to the display.

UMB202 Camera Plate Installation

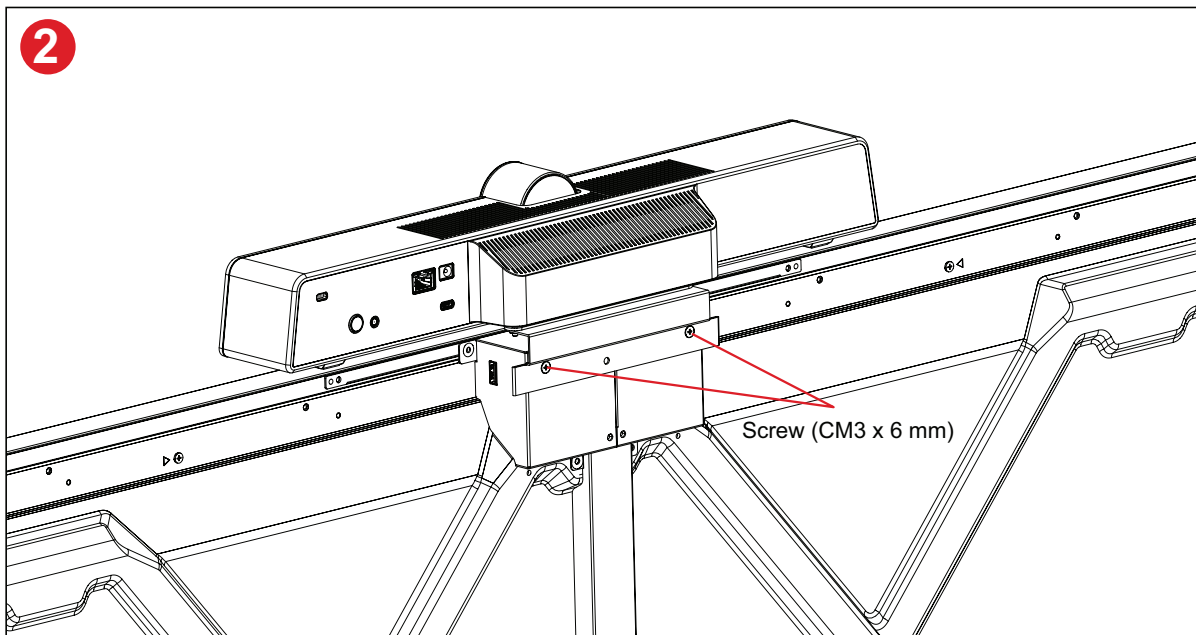
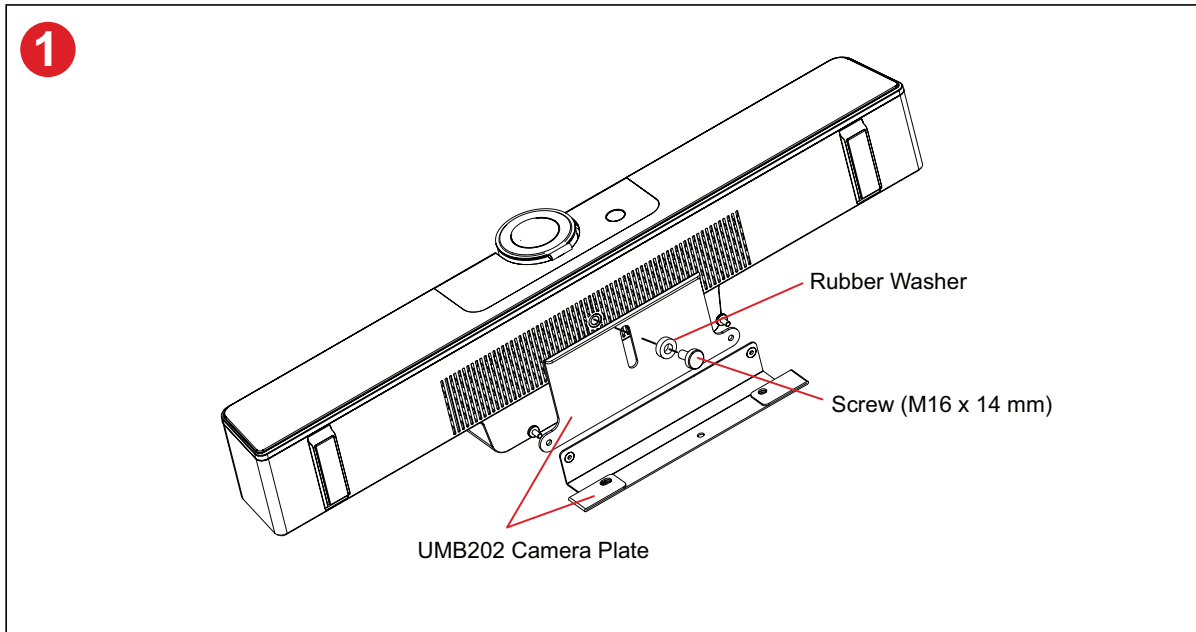

Using the ViewBoard

Turning On/Off the ViewBoard

1. Ensure the power cord is connected, plugged into a power outlet, and the power switch is in the “On” position.

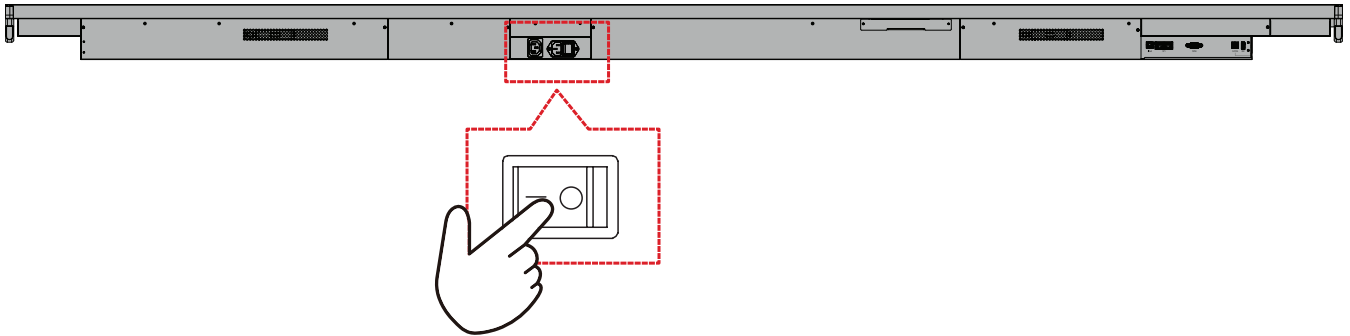

NOTE: The Power Switch is located at the bottom of the ViewBoard.

2. Press the **⏻ Power** button to turn on the ViewBoard.

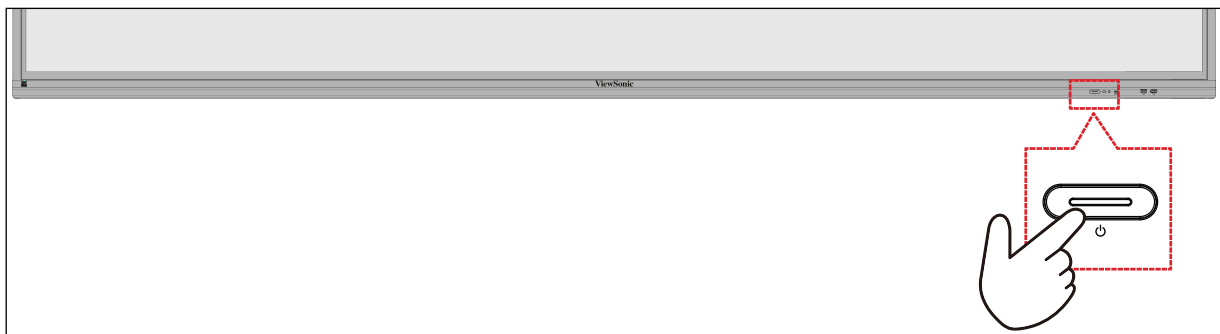

3. To turn the ViewBoard off, press and hold the **⏻ Power** button.

NOTE: **AC OUT** can be connected to another device. However, the output power use must be $< 250W$.

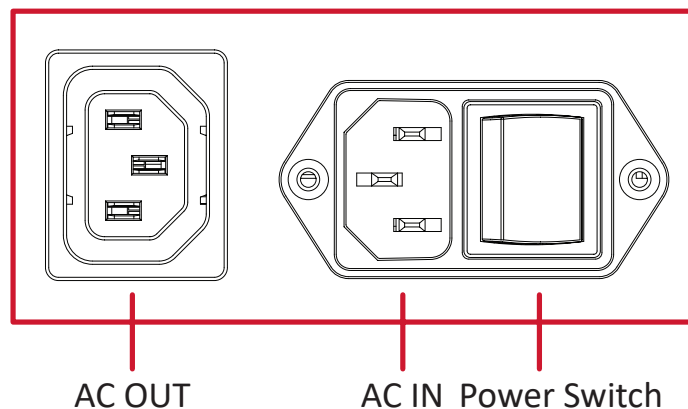

AC OUT

AC IN Power Switch

Initial Launch Setup

When you first turn on your ViewBoard, an initial setup wizard will launch.

1. Choose your preferred Language.



2. Setup and connect to a network.

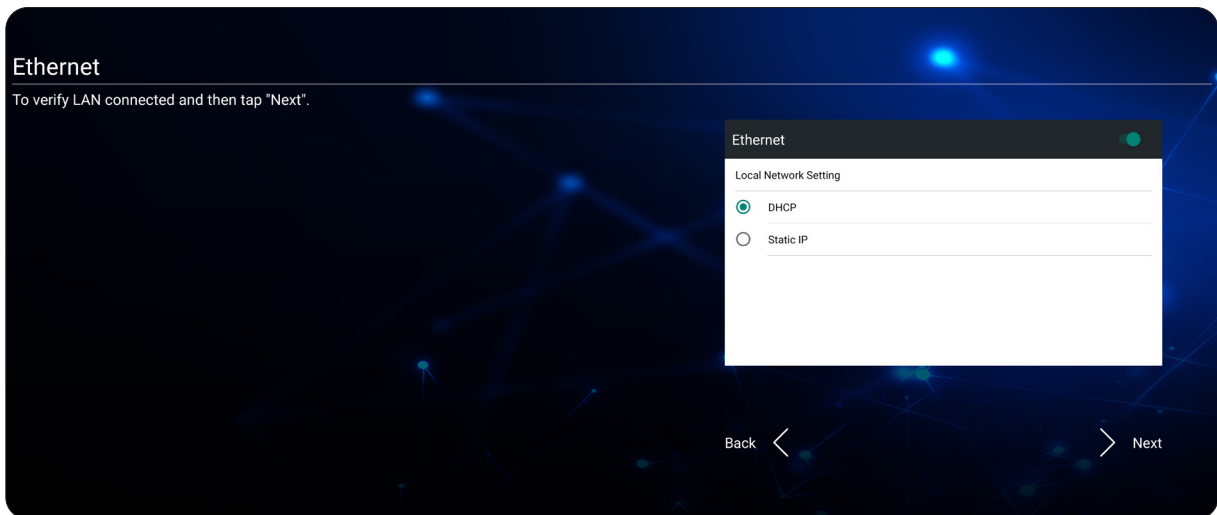

3. Set and adjust the Date and Time as needed.

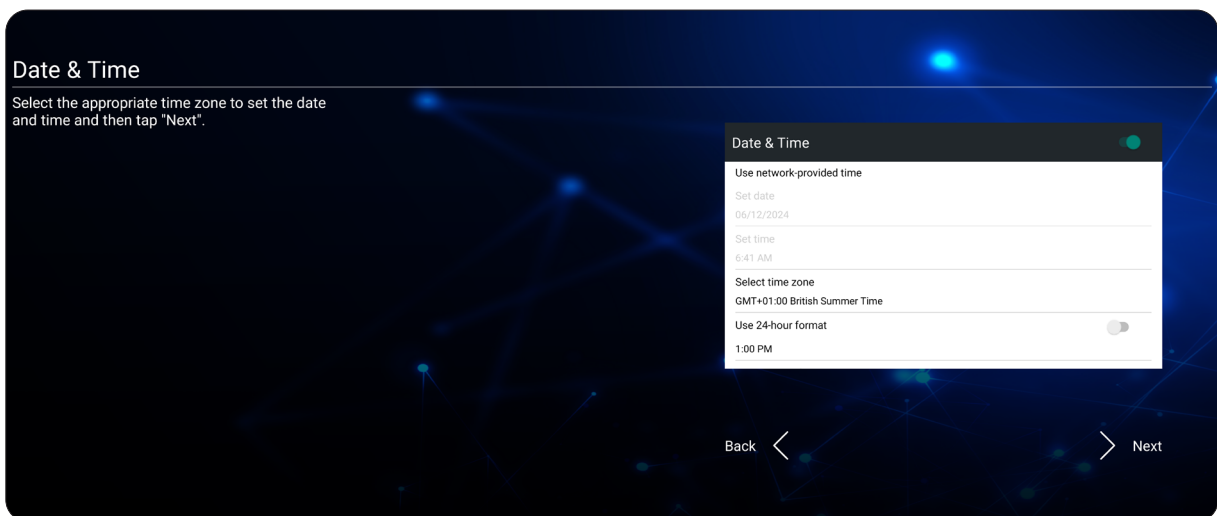

4. Select your preferred System Mode.

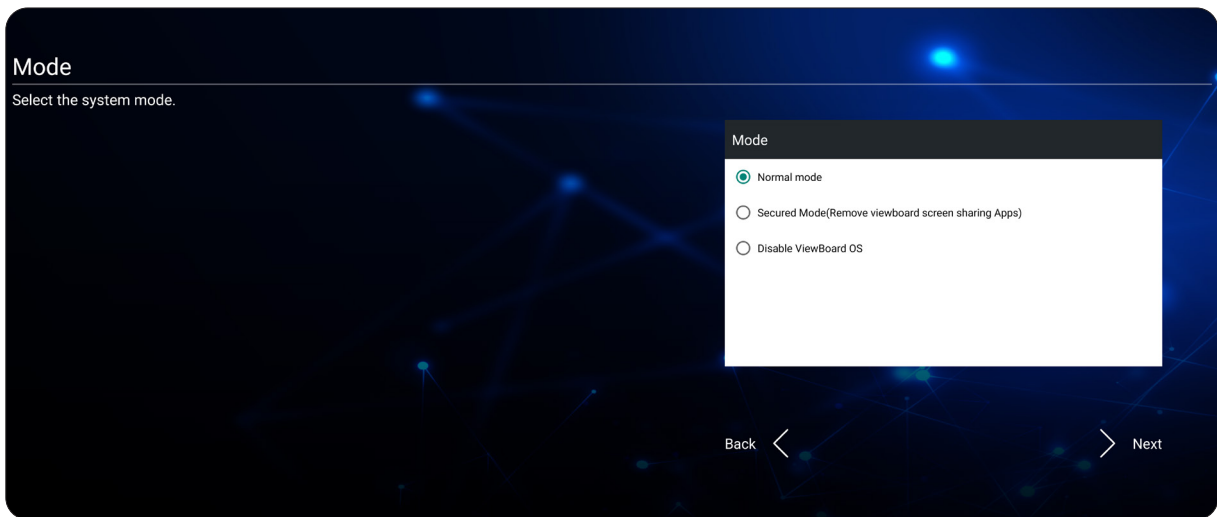

5. Setup the Power Saving Plan.

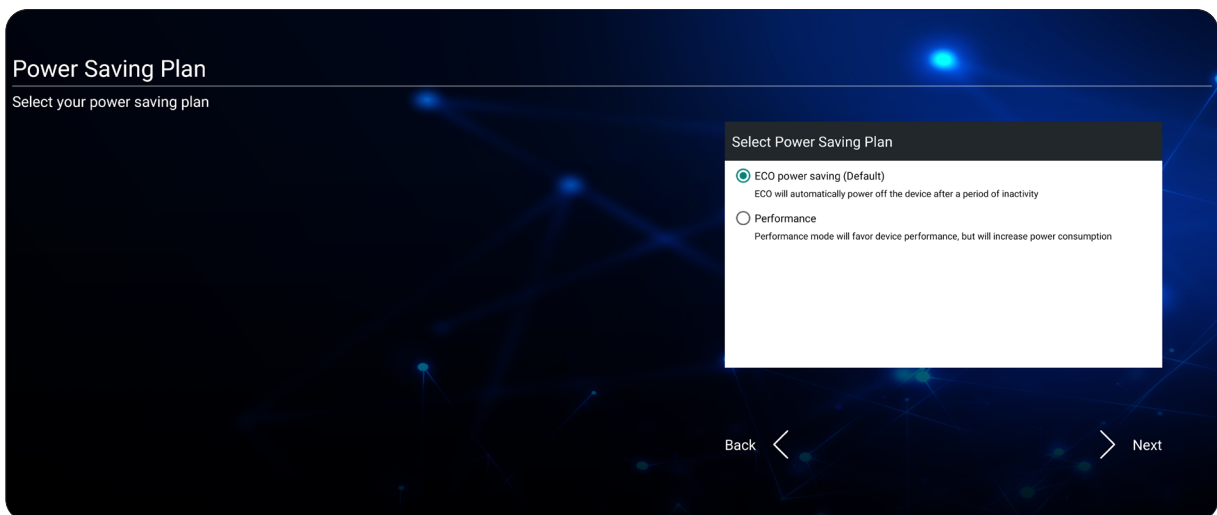

6. Accept or decline the Privacy and Copyright Protection Terms.

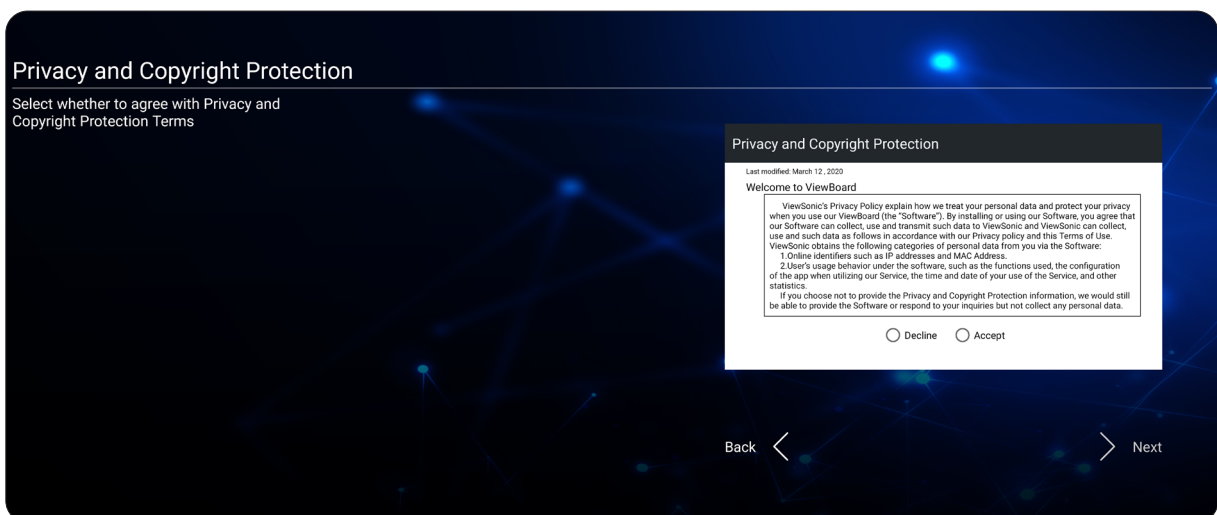

Home Screen

On the Home Screen select from **Use as Guest** and **Sign In**.

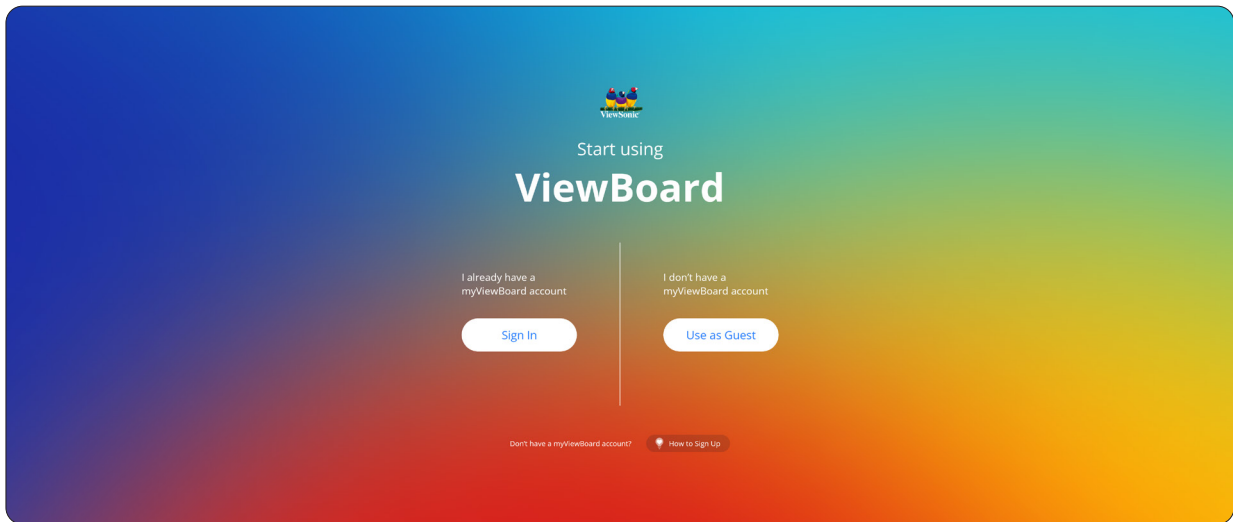

How to Sign Up

Select the **How to Sign Up** button at the bottom of the screen, then scan the QR code and follow the directions to log in.

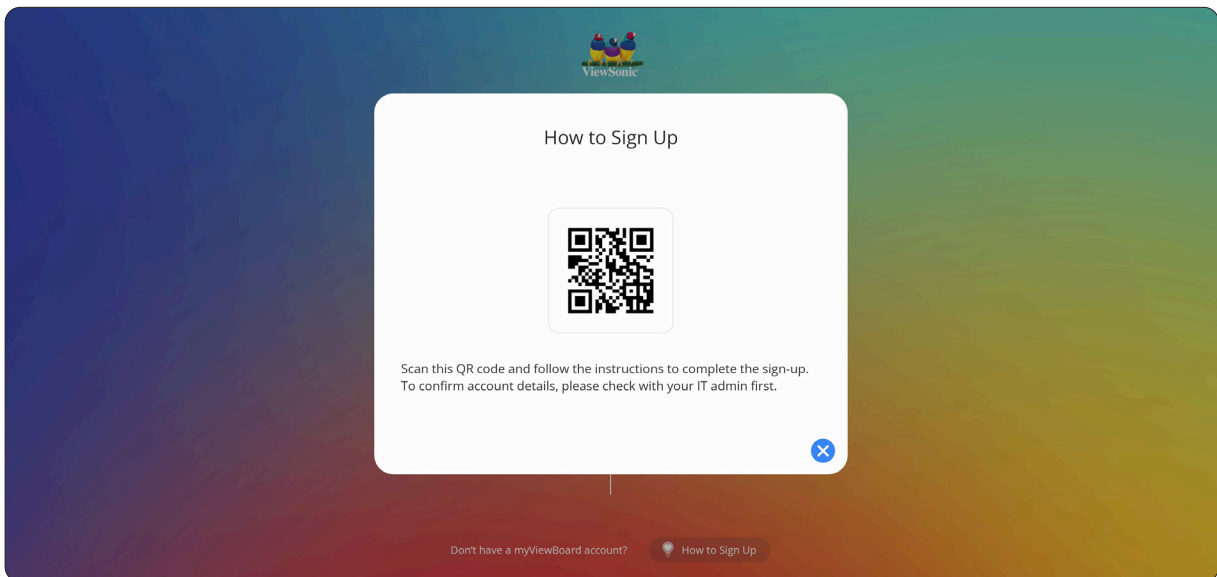

Use as Guest

Select the **Use as Guest** button to log in with a guest account.

NOTE: Please note that user settings cannot be saved when logging in with a guest account.

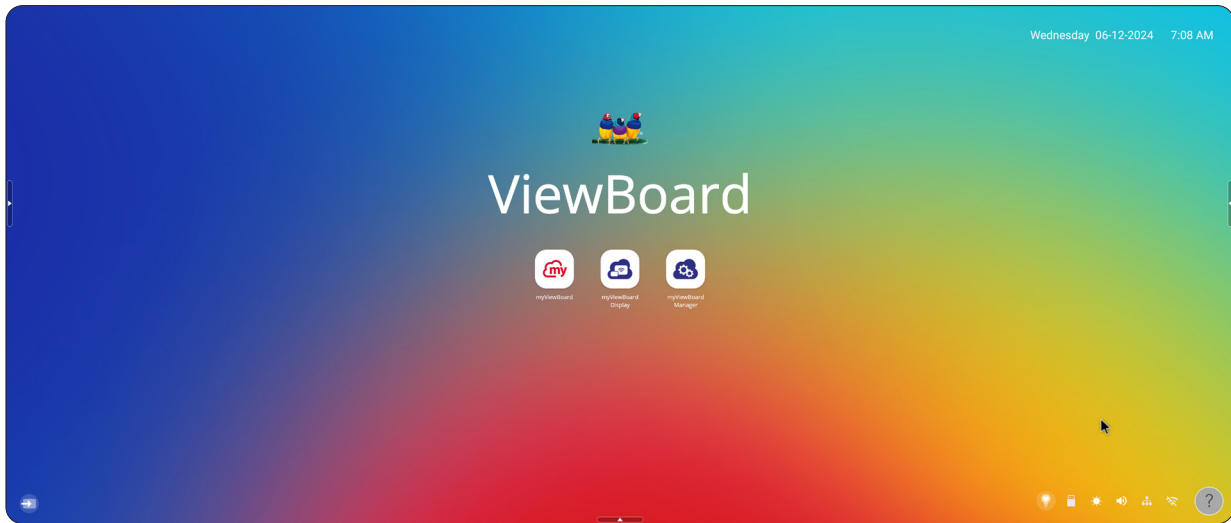

Sign In

Select the **Sign In** button to log in with various accounts.

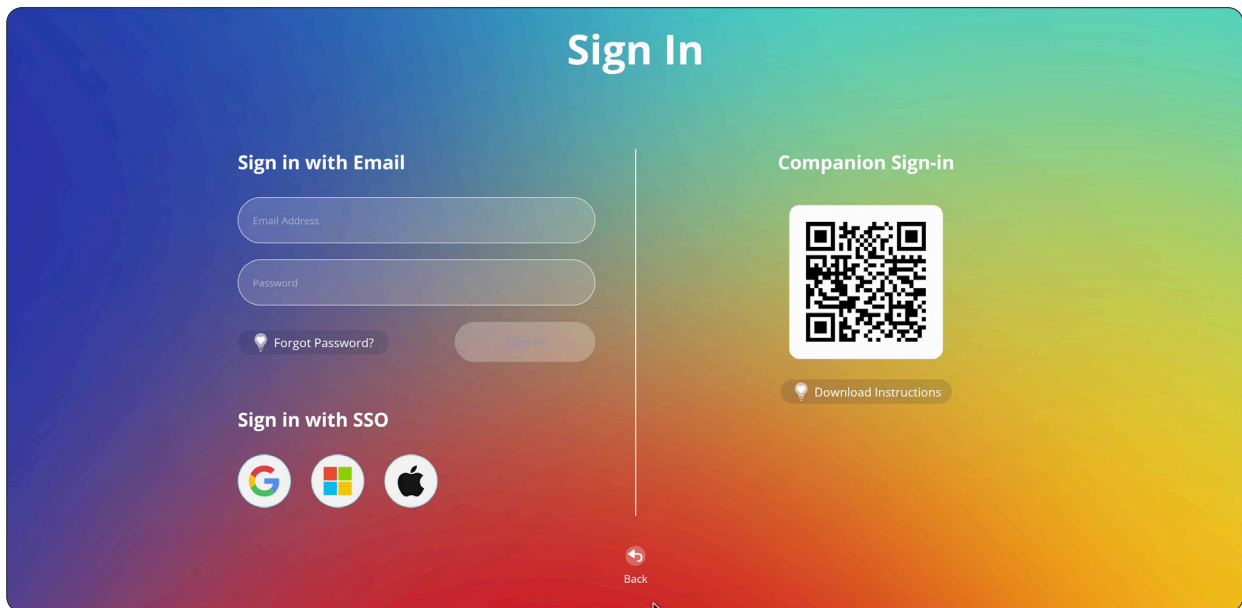

Home Screen Message

The Home Screen message can be edited by selecting it directly on the Home Screen.

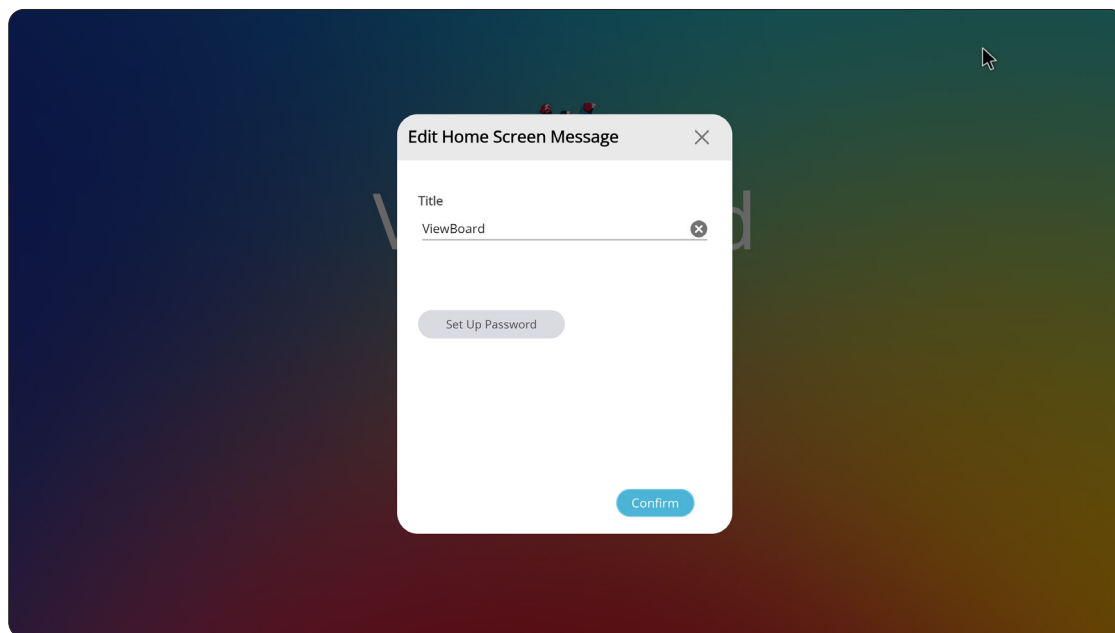

Additionally, a password can be set by selecting the **Set Up Password** button.

Toolbar

The Toolbar is where applications and tools can be found. Trigger icons are on the right, left, and bottom edge of the screen for quick access.

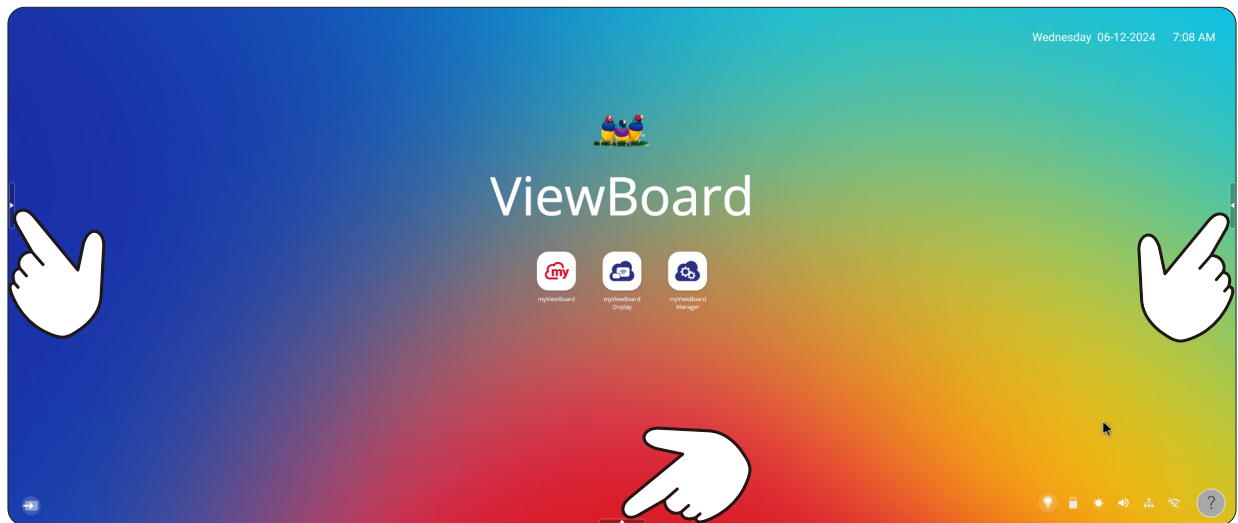







To launch an application or tool:

1. Tap a Toolbar trigger icon.
2. Tap on the application or tool.

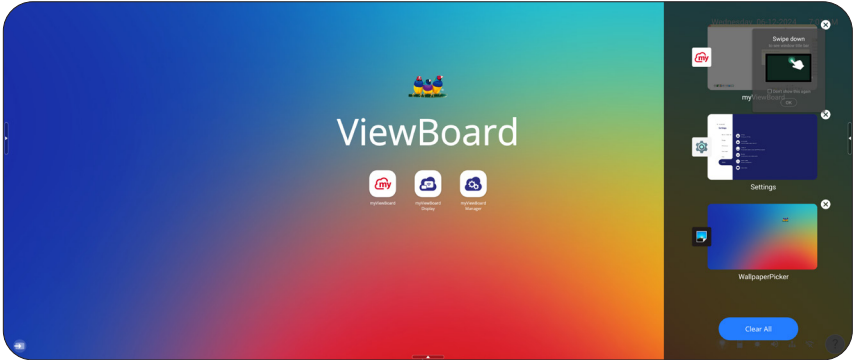

NOTE: The default toolbar setting is to be available for all input sources; however, users can go to: **Settings > Preference > Toolbar settings** to adjust the options: (1) Show side toolbar, (2) Hide side toolbar, (3) Disable in all input sources.

Toolbar Icons

Icon	Description
 Return	Return to the previous operation screen. NOTE: Only for the ViewBoard source.
 Home	Return to the Home Screen.
 Recent	Display all currently open applications. 
 Applications	View all installed applications.
 File Folder	Browse and open files.
 Tools	Quickly view and adjust various frequently used tools.
 Input Source	Select and change the input source signal.



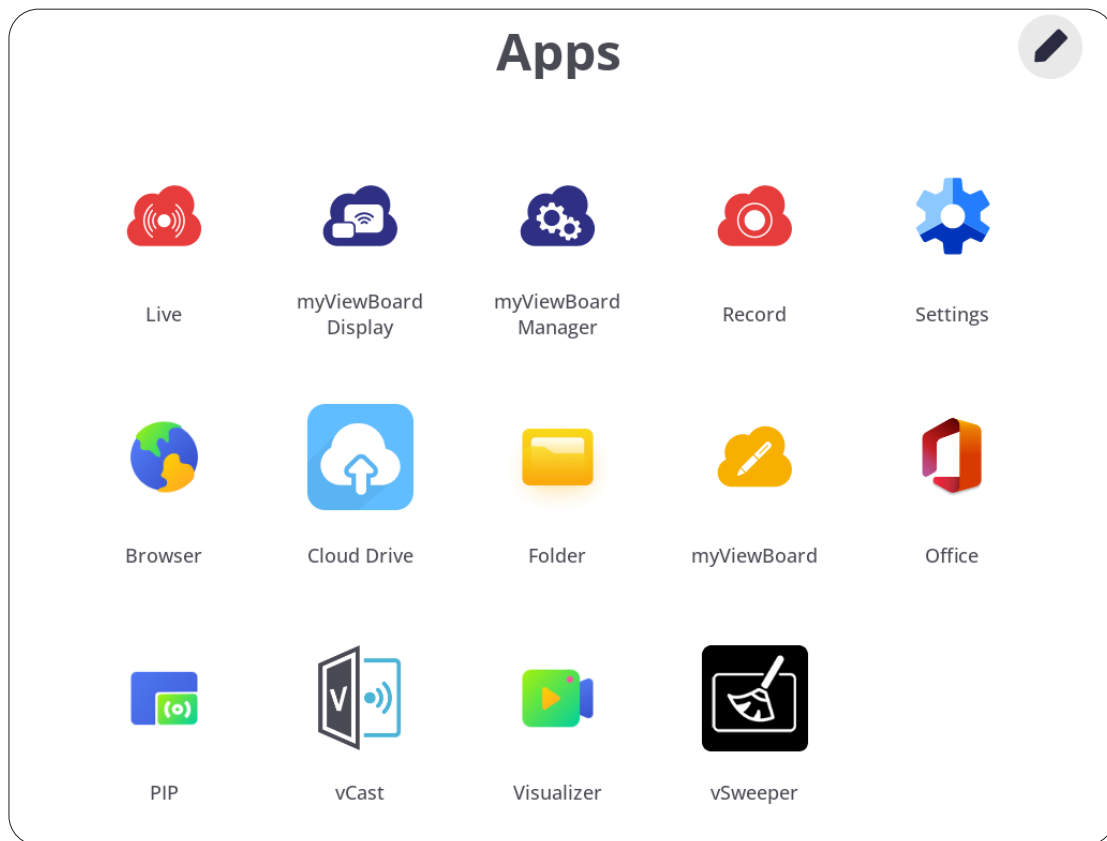

Applications

Much like any smart phone or tablet you can install several different applications.





Applications can be accessed from the Toolbar, directly from the Home Screen via shortcuts, or by selecting the **Applications** icon ().





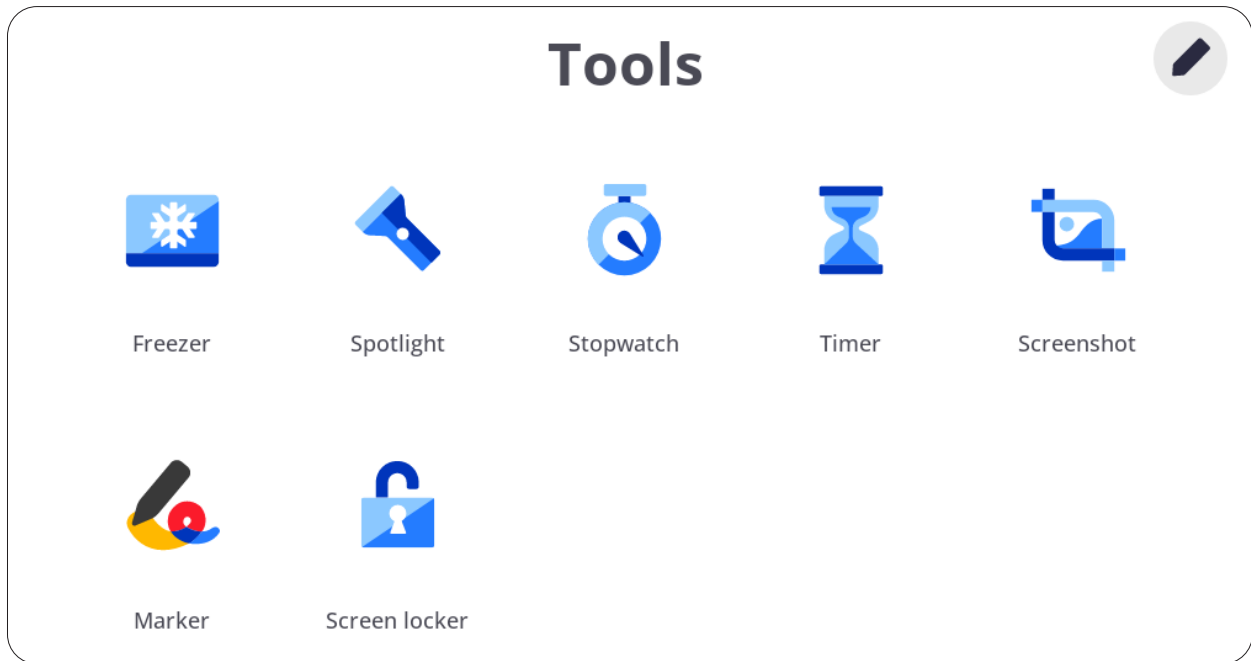

NOTE: The following included application descriptions are not a comprehensive list and will vary by the user.

Icon	Description
	<u>myViewBoard Display</u> Wirelessly mirror screens to a larger display.
	<u>myViewBoard Manager</u> Remotely manage multiple installations of ViewSonic devices.
	<u>myViewBoard Whiteboard</u> A digital whiteboarding application.
	<u>Settings</u> Access the System Settings.
	<u>vCast</u> Working with ViewBoard Cast software, receive vCastSender laptop screens (Windows/Mac/Chrome) and mobile (iOS/Android) users' screens, photos, videos, annotations, and camera(s).

Tools



Various tools can be accessed from the Toolbar, directly from the Home Screen via shortcuts, or by selecting the **Tools** icon ().





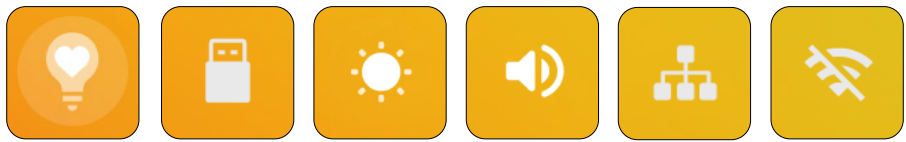
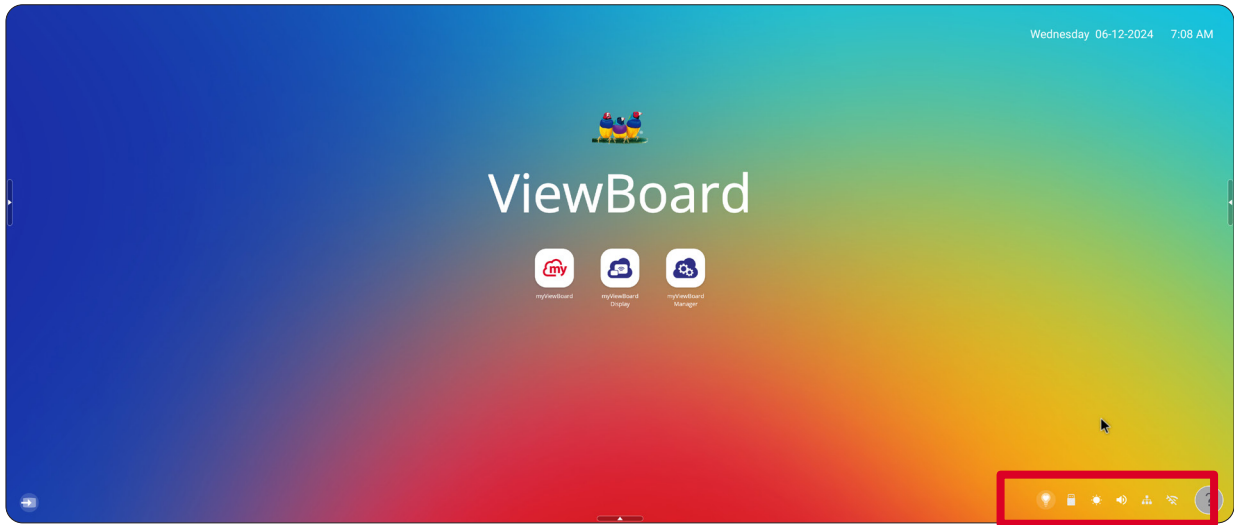

Icon	Description
	<u>Freezer</u> Convert the currently displayed content into a still image; then you can zoom in, zoom out, go back to full screen, and exit.
	<u>Spotlight</u> Highlight the focus content zone. Tap the setting icon to adjust the spotlight size and alpha blending effect.
	<u>Stopwatch</u> Tapping Start will initiate the stopwatch. At any time, the stopwatch can be paused, resumed, split, or reset.
	<u>Timer</u> A countdown timer with an optional alarm setting. Touch and swipe to adjust the numeric values, then click Start. At any time, the countdown timer can be paused, resumed, or reset.
	<u>Screenshot</u> Take a screenshot of the current screen.
	<u>Marker</u> Annotate the overlay of any input source with a pen or brush.
	<u>Screen Locker</u> Lock the display's screen for added security.

Control Bar

Frequently used settings and tools can be accessed quickly through the Control Bar.



Control Bar Icons

Icon	Description
 Online Guide	Learn the basics of ViewBoard online by scanning the QR code that appears after tapping the icon.
 USB	If a USB storage device is connected, the USB icon will be visible. Tapping the icon will open the USB storage device's folder.
 Brightness	Adjust the brightness level of the display.
 Sound	Adjust the volume level of the display.
 Ethernet	Shortcut to Network & Internet Ethernet settings. Enable or disable Ethernet connection.
 Wireless	Shortcut to Network & Internet Wi-Fi settings. Enable or disable Wi-Fi and connect to a wireless network.

On-Screen Display (OSD) Menu - General Settings

Access **Input Source**, **Display**, and other general settings through the OSD Menu.

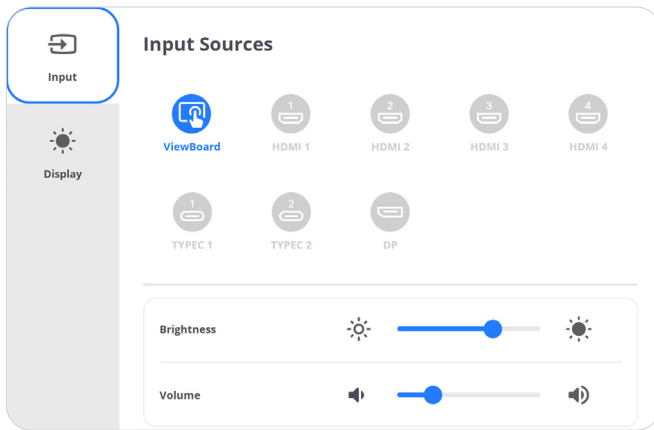

Input Source Menu

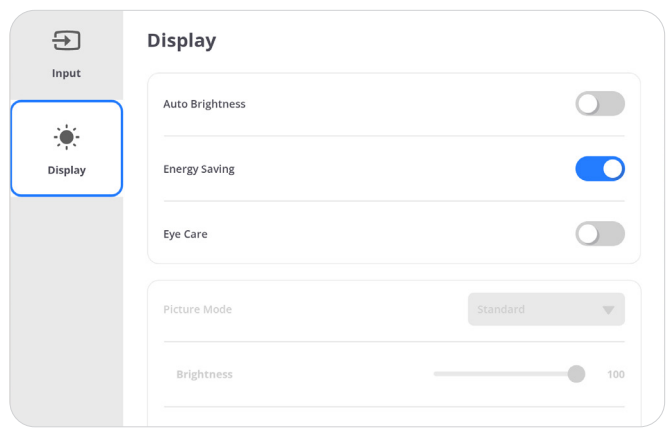

Display Menu

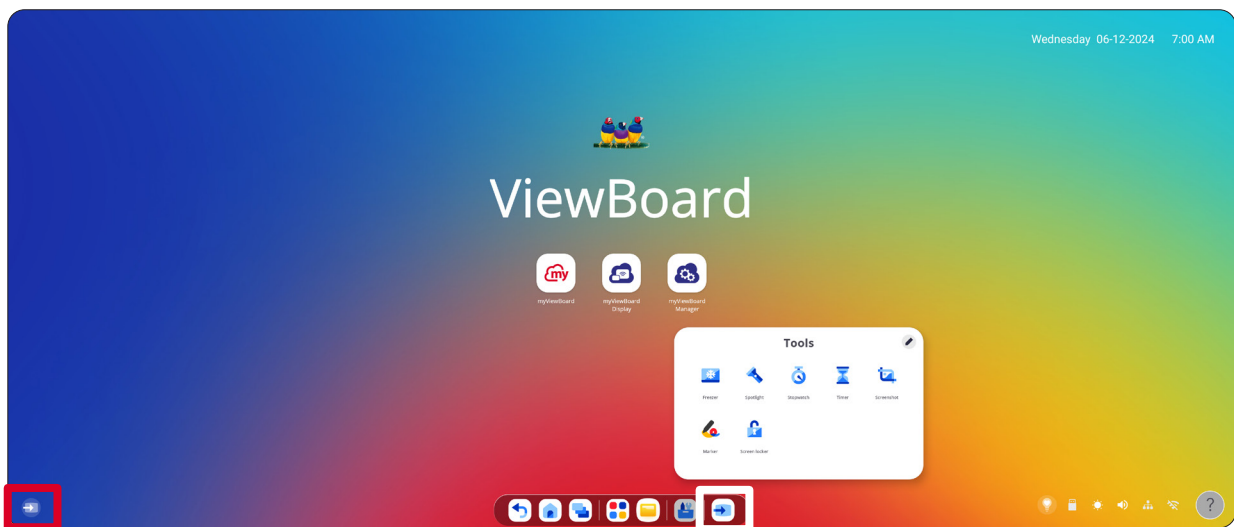

Open the OSD Menu by pressing **INPUT** on the remote control, touching the **Input Source** icon (➡) on the Home Screen or the **Input Source** icon (➡) in the Toolbar.

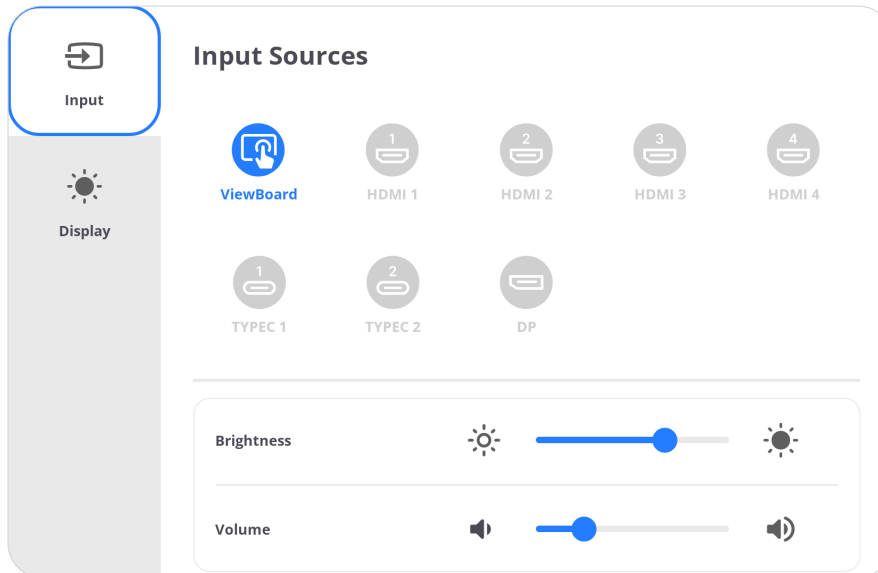

Input Source





To select an input source:

1. Press **INPUT** on the remote control, touch the **Input Source** icon () on the Home Screen or the **Input Source** icon () in the Toolbar to display the Input Source menu.
2. Press **▼/▲/◀/▶** on the remote control to select the input source you want.
NOTE: The PC source will only be visible when a slot-in computer is installed.
3. Press **ENTER** on the remote control, or touch the input source.
4. Press **BACK** on the remote control, or touch a blank area outside of the menu to exit.

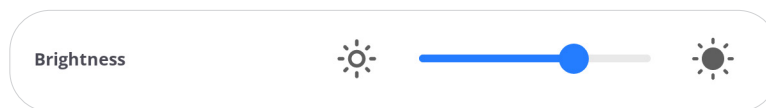

To adjust the brightness:

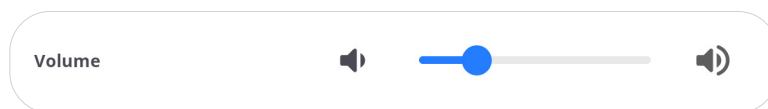

1. Press **INPUT** on the remote control, touch the **Input Source** icon () on the Home Screen or the **Input Source** icon () in the Toolbar to display the Input Source menu.
2. Touch and drag the brightness slider directly to adjust the backlight value.
3. Press **BACK** on the remote control, or touch a blank area outside of the menu to exit.

To adjust the volume:



1. Press **INPUT** on the remote control, touch the **Input Source** icon () on the Home Screen or the **Input Source** icon () in the Toolbar to display the Input Source menu.
2. Touch and drag the volume slider directly to adjust the value, or press **VOL +/VOL -** on the remote control to adjust. Additionally, pressing **Mute** () on the remote control will mute/unmute the volume.
3. Press **BACK** on the remote control, or touch a blank area outside of the menu to exit.

Display

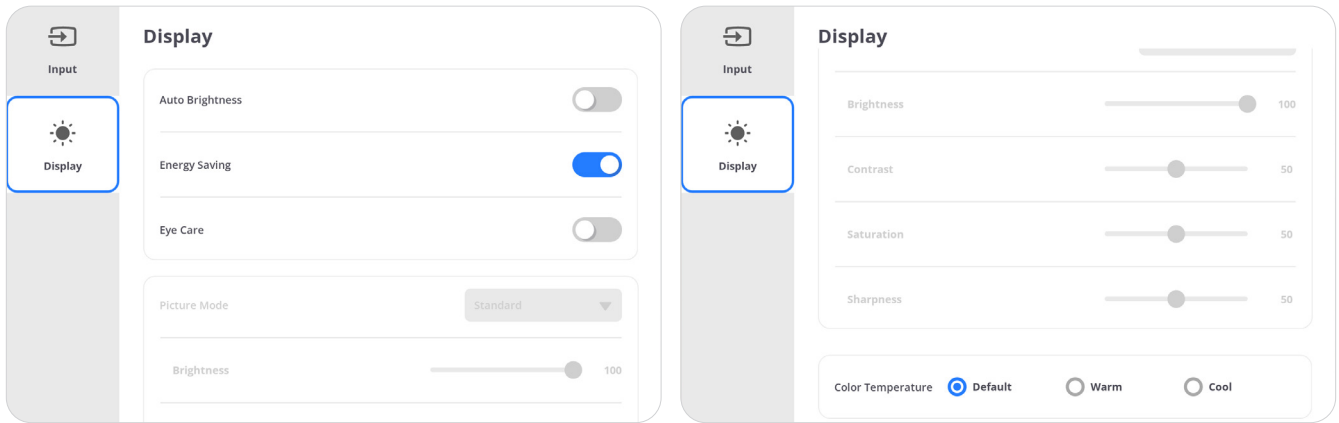

To adjust the display settings:

1. Press **INPUT** on the remote control, touch the **Input Source** icon (→) on the Home Screen or the **Input Source** icon (→) in the Toolbar to display the Input Source menu. Then select the **Display** tab.
2. Press ▼/▲/◀/▶ on the remote control to select the menu option you want.
3. Press **ENTER** on the remote control to confirm or press ◀/▶ to adjust the menu option. Additionally, touch/adjust the menu option directly.
4. Press **BACK** on the remote control, or touch a blank area outside of the menu to exit.

Display Menu Options

Item	Description										
Auto Brightness	Automatic brightness adjustment. Adjusts maximum brightness according to ambient light levels.										
Energy Saving	Enable to reduce power consumption.										
Eye Care	Adjusts the filter that blocks high-energy blue light for a more comfortable viewing experience.										
Picture Mode	Select a predefined picture setting.										
	<table border="1"> <thead> <tr> <th data-bbox="480 591 691 640">Mode</th> <th data-bbox="691 591 1401 640">Description</th> </tr> </thead> <tbody> <tr> <td data-bbox="480 640 691 689">Standard</td> <td data-bbox="691 640 1401 689">Default picture mode.</td> </tr> <tr> <td data-bbox="480 689 691 815">Bright</td> <td data-bbox="691 689 1401 815">Maximizes the brightness of the display. This mode is suitable for environments where extra-high brightness is required (e.g., well-lit rooms).</td> </tr> <tr> <td data-bbox="480 815 691 864">Soft</td> <td data-bbox="691 815 1401 864">A high brightness level with lower contrast level.</td> </tr> <tr> <td data-bbox="480 864 691 913">Custom</td> <td data-bbox="691 864 1401 913">Customize the picture settings.</td> </tr> </tbody> </table>	Mode	Description	Standard	Default picture mode.	Bright	Maximizes the brightness of the display. This mode is suitable for environments where extra-high brightness is required (e.g., well-lit rooms).	Soft	A high brightness level with lower contrast level.	Custom	Customize the picture settings.
	Mode	Description									
	Standard	Default picture mode.									
	Bright	Maximizes the brightness of the display. This mode is suitable for environments where extra-high brightness is required (e.g., well-lit rooms).									
Soft	A high brightness level with lower contrast level.										
Custom	Customize the picture settings.										
Standard	Default picture mode.										
Bright	Maximizes the brightness of the display. This mode is suitable for environments where extra-high brightness is required (e.g., well-lit rooms).										
Soft	A high brightness level with lower contrast level.										
Custom	Customize the picture settings.										
Brightness	Adjusts background black levels of the screen image. The higher the value, the brighter the image. Lower values will result in a darker image.										
Contrast	Adjusts the difference between the image background (black level) and the foreground (white level). Use this to set the peak white level after you have previously adjusted the Brightness setting to suit your selected input and viewing environment.										
Saturation	The amount of color in a picture. Lower settings produce less saturated colors; in fact, a setting of “0” removes that color from the image entirely. If the saturation is too high though, that color will be overpowering and unrealistic.										
Sharpness	A high value results in a sharper picture; a low value softens the picture.										
Color Temperature	Adjust the color temperature value.										

Low Blue Light Filter and Eye Health

The Blue Light Filter blocks high-energy blue light for a more comfortable viewing experience.

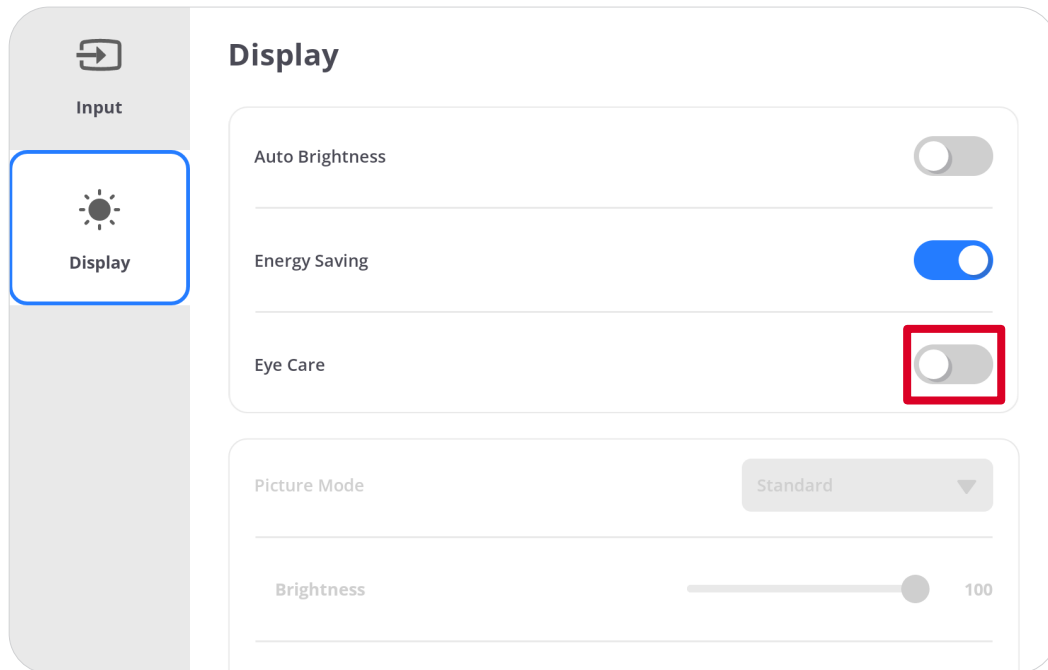

Calculating Breaks

When viewing screens for extended periods, it is recommended to take periodic breaks from viewing. Short breaks of at least 10 minutes are recommended after one (1) hour of continuous viewing.

Taking shorter, more frequent breaks are generally more beneficial than longer, less frequent breaks.

Focus Fatigue (20-20-20 Rule)

To reduce the risk of eye fatigue by constantly looking at the screen, look away from the screen at least every 20 minutes and gaze at a distant object (at least 20 feet away) for at least 20 seconds.

Looking at Distant Objects

While taking breaks, users can further reduce eye strain and dryness by focusing on objects that are further away from them for 10-15 seconds, then gaze at something up close for 10-15 seconds. Repeat this up to 10 times. This exercise reduces the risk of your eyes' focusing ability to "lock up" after prolonged computer work.

Eye and Neck Exercises

Eye Exercises

Eye exercises can help minimize eye strain. Slowly roll your eyes to the left, right, up, and down. Repeat as many times as needed.

Exercises for the eyes

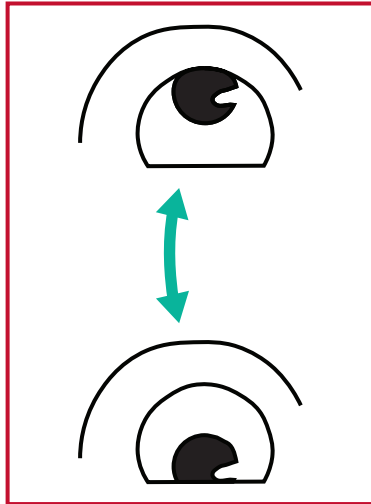

(1) Keep the body and the head upright. Move the eyes up to look at the ceiling, then turn down to look at the floor.

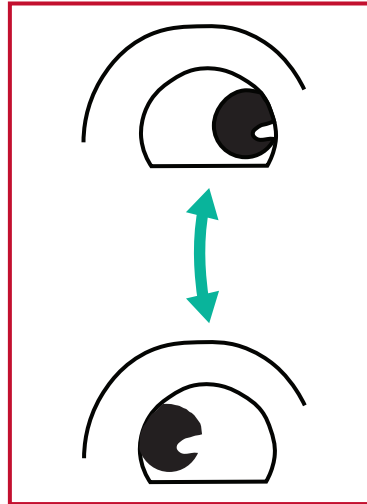

(2) Move the eyes left and right slowly to look at objects on the two sides.

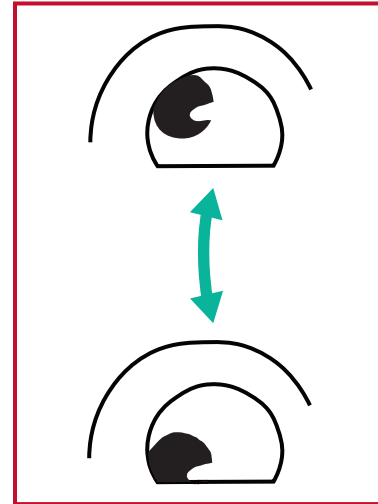

(3) Move the eyes to look at objects at the right upper direction and then right lower direction. Repeat for the left upper and left lower directions.

Neck Exercises

Neck exercises can also help minimize eye strain. Relax your arms and let them hang at your sides, bend forward slightly to stretch the neck, turn your head to the right and to the left. Repeat as many times as needed.

System Settings

When the display is in the ViewBoard input source, press **MENU** (☰) on the remote control or tap the setting icon (⚙️) to enter the **Settings** menu.

Network & Internet

Check current network connection status and set up and manage Wi-Fi, Ethernet, Wireless Hotspot, Bluetooth, and VPN.



NOTE:

- Ethernet will disable automatically when Wi-Fi is enabled. Wi-Fi will disable automatically when Ethernet is enabled. Wi-Fi will disable when Wireless hotspot is enabled.
- The device cannot connect to the Internet when Wireless Hotspot is enabled.

Wi-Fi

Setup and manage wireless access points.

- Tap the toggle button to turn Wi-Fi **On** or **Off**.

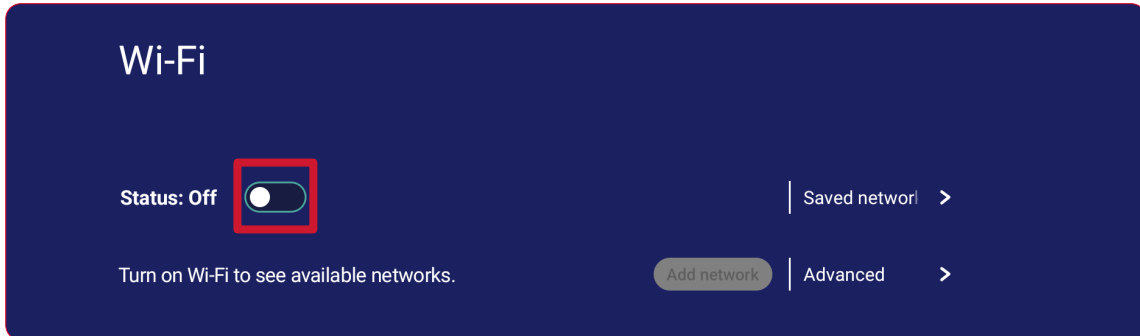

- Once **On**, you can: **Add a Network**, view **Saved Networks**, **Refresh** the network list, or view **Advanced** settings.

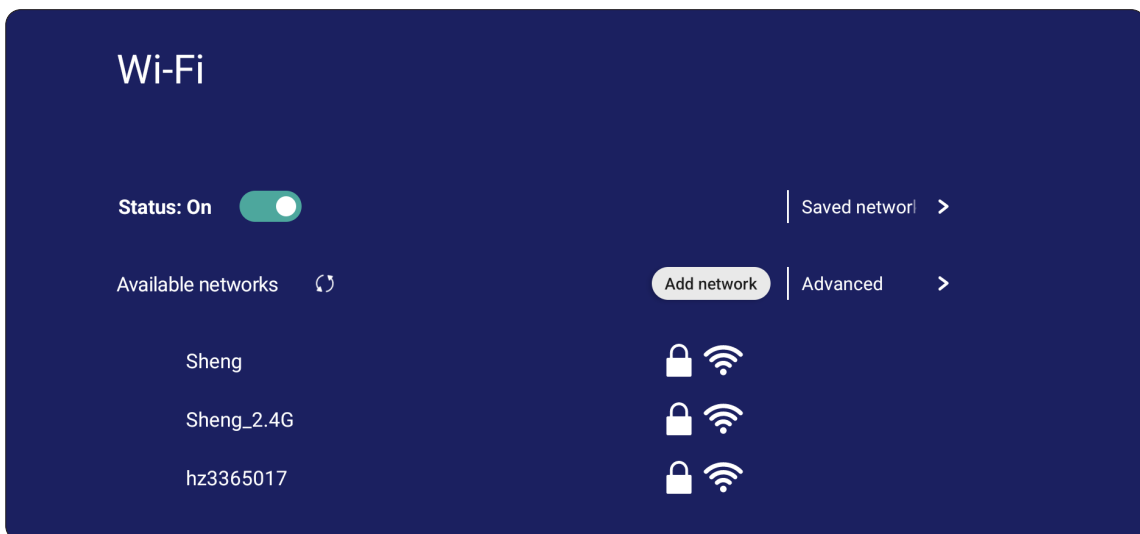

- In **Advanced** settings, you can toggle **Network notifications On** or **Off** and view **Network card info**.

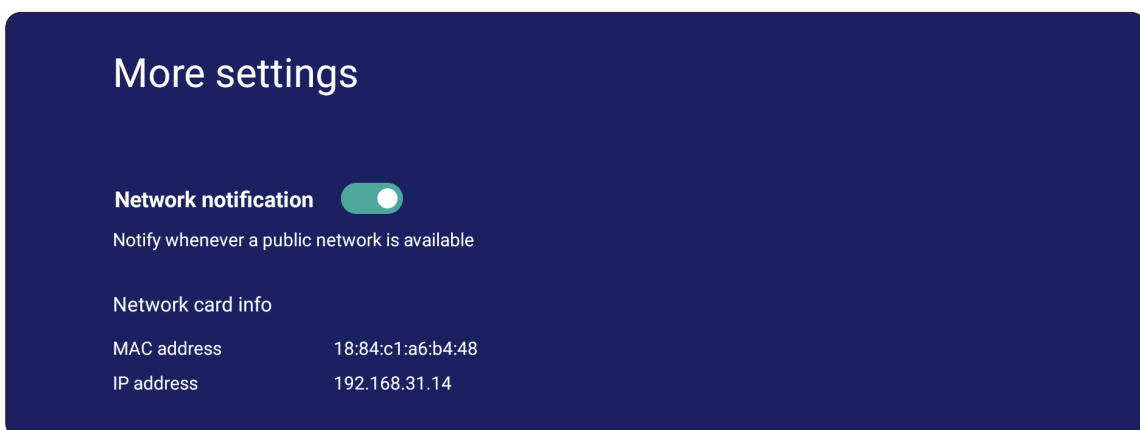

Ethernet

Set the local network and proxy.

- Tap the drop down menu to connect/disconnect the Ethernet.

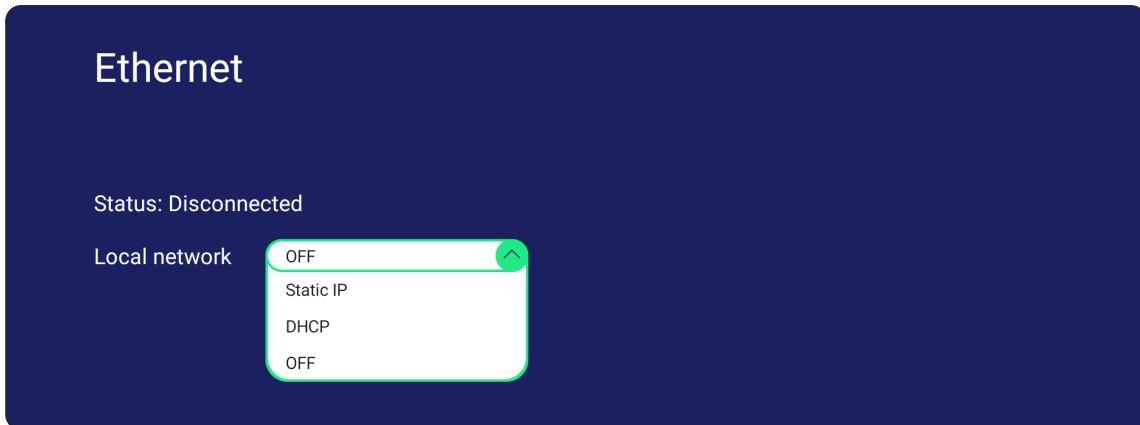

- You can adjust **Local network** and **Proxy** settings as well.

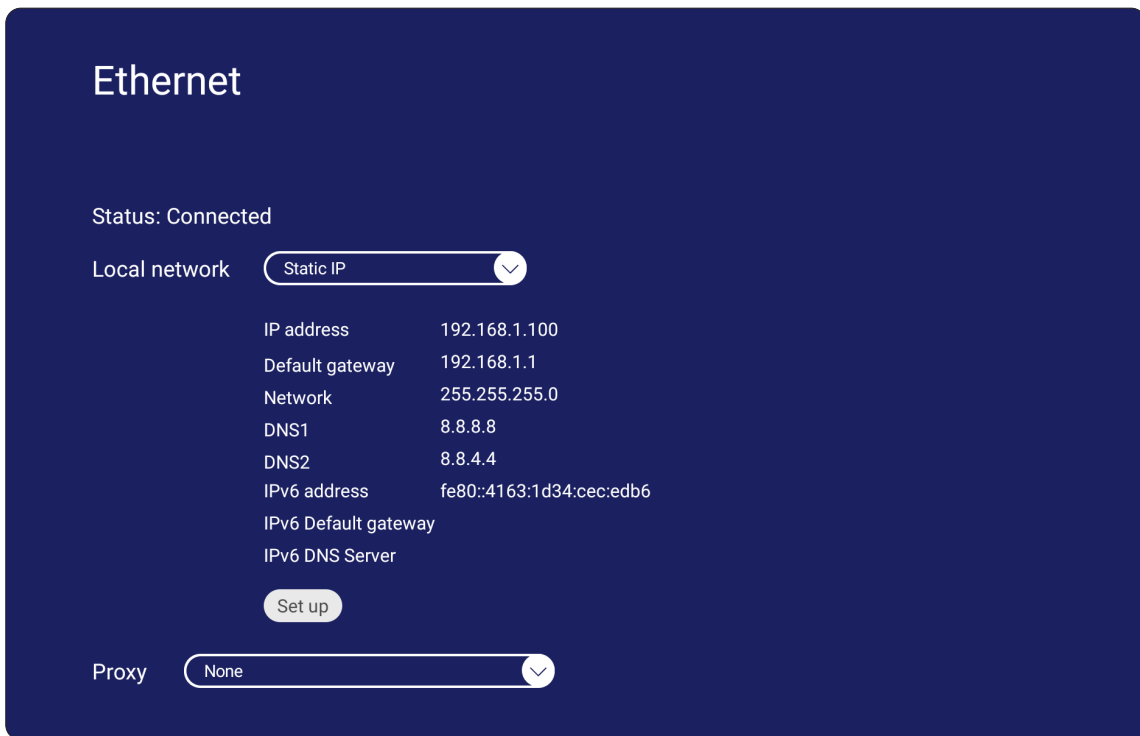

Wireless Hotspot

Set and share your internet connection with other devices.

- Tap the toggle button to turn **Wireless hotspot On** or **Off**.

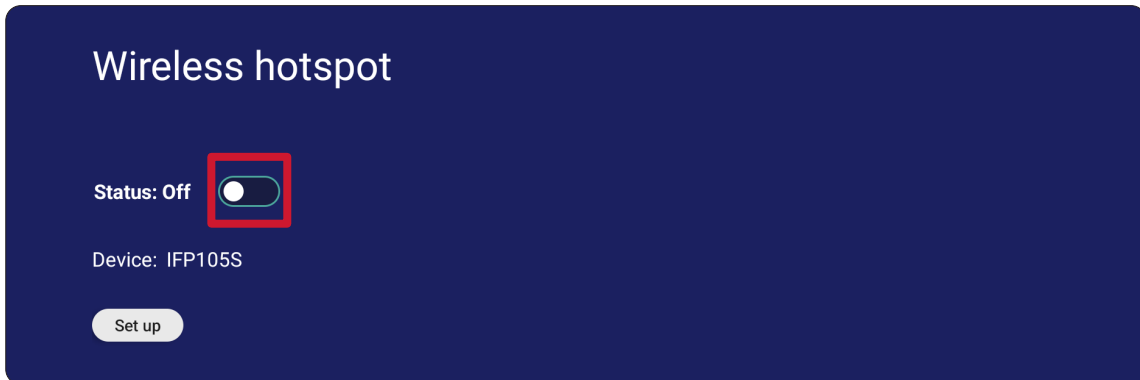

- Tap **Set up** to set the **Network name**, **Security**, and **Password**.

A screenshot of the 'Set up hotspot' dialog box. It has a title bar 'Set up hotspot'. The 'Network name' field contains 'IFP105S'. The 'Security' dropdown menu is set to 'wifi_security_wpa2'. The 'Password' field is empty, with a series of dots and a visibility icon. Below the password field, there is a note: 'The password must have at least 8 characters.' At the bottom, there are 'Cancel' and 'Save' buttons.

Bluetooth

Manage Bluetooth connections, set the device name and discoverability.

- Touch the toggle to turn **Bluetooth** on or off. Once on, users can select a listed device to pair and connect to, rename their device, remove a device, or receive files.

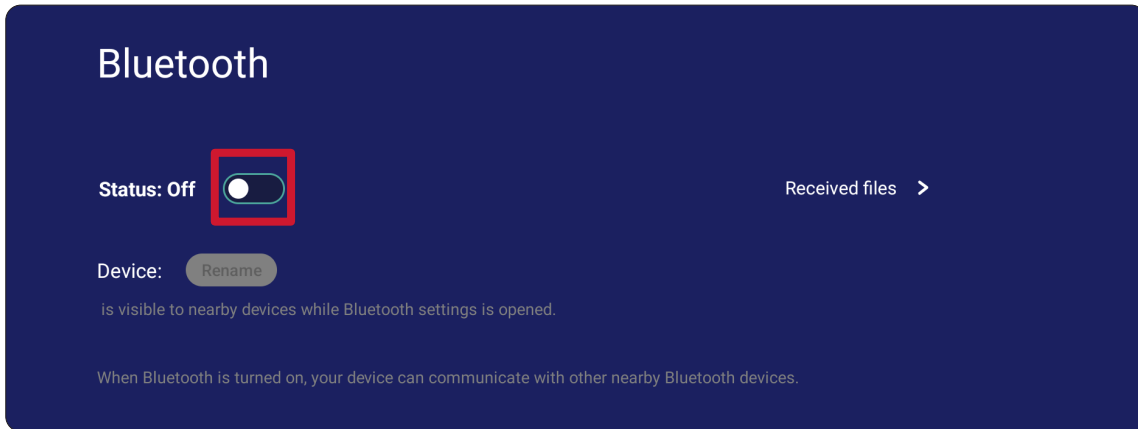

VPN

Setup and manage Virtual Private Networks.

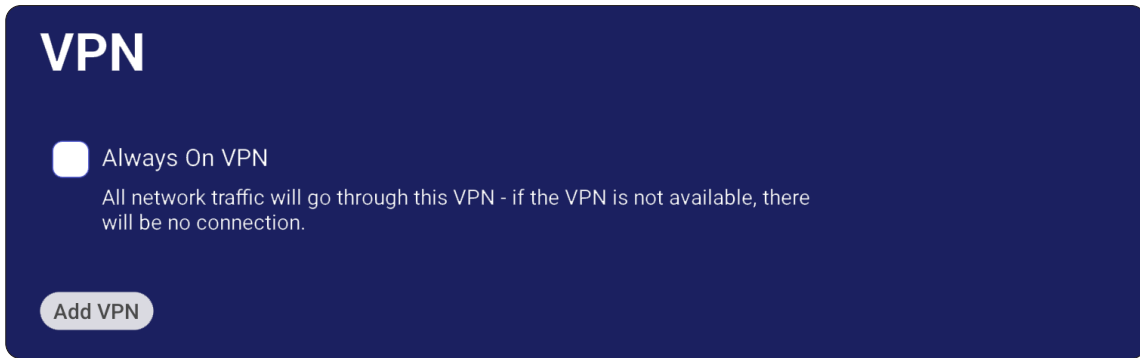

To create a VPN profile:

1. Go to: **Settings > Network & Internet > VPN** and tap **Add VPN**.

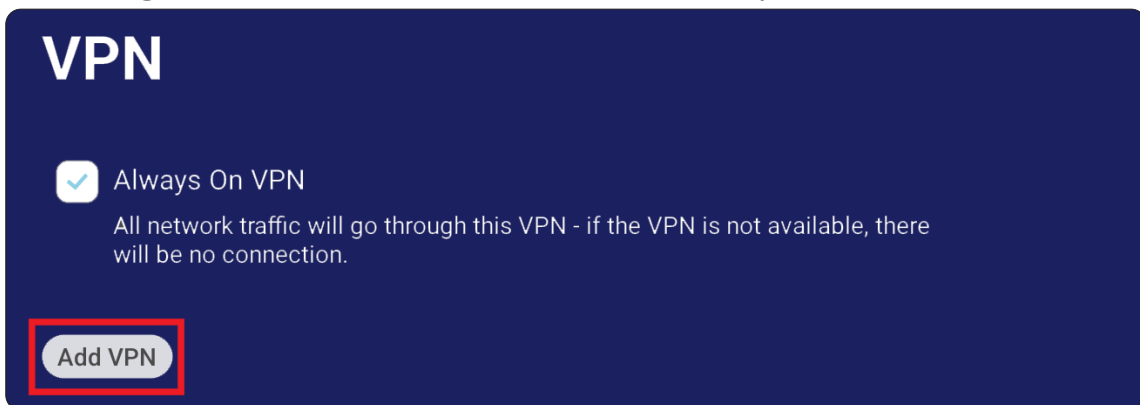

2. Key in the **Name**.

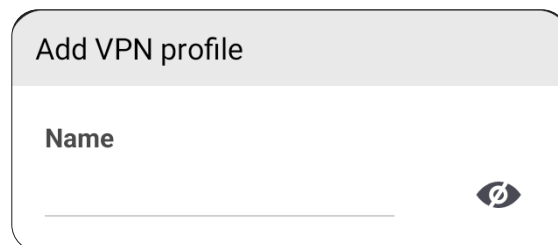

The screenshot shows a dialog box titled 'Add VPN profile'. It has a light gray header with the title. Below the header, there is a text input field labeled 'Name'. The input field is currently empty and has a small eye icon to its right, indicating that the text is hidden. The entire dialog box has rounded corners and a thin gray border.

3. Select the VPN Type.

The screenshot shows the 'Add VPN profile' dialog box. The 'Name' field is empty. The 'Type' dropdown menu is open, showing the following options: PPTP (selected), PPTP, L2TP/IPSec PSK, L2TP/IPSec RSA, IPSec Xauth PSK, IPSec Xauth RSA, and IPSec Hybrid RSA. A 'Save' button is visible at the bottom right.

4. Choose to enable/disable **PPP encryption (MPPE)** and/or show **Advanced options**.

The screenshot shows the 'Add VPN profile' dialog box with the 'Type' dropdown menu set to 'L2TP/IPSec PSK'. The 'Server address' field is empty. The 'PPP encryption(MPPE)' checkbox is checked. The 'Advanced options' section is expanded, showing 'Dns search domains', 'Dns servers', and 'Forwarding_routes' fields, all of which are empty. 'Cancel' and 'Save' buttons are at the bottom.

Display

Adjust the Wallpaper, Protection, and HDMI Out settings.



Wallpaper

Users can change their wallpaper with default images, or use their own by tapping the add icon (+) and selecting the image file.

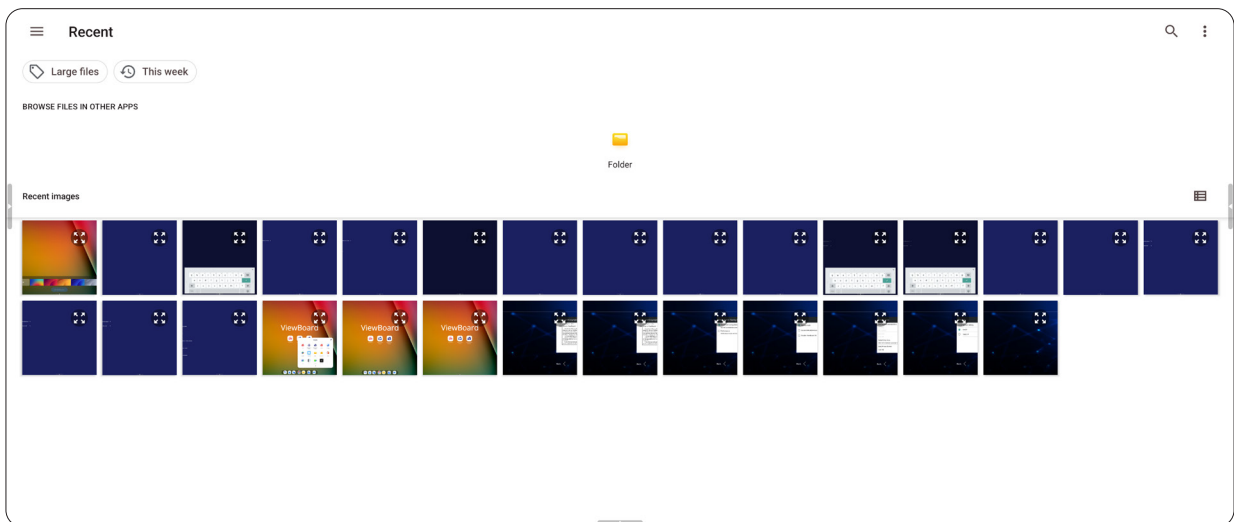
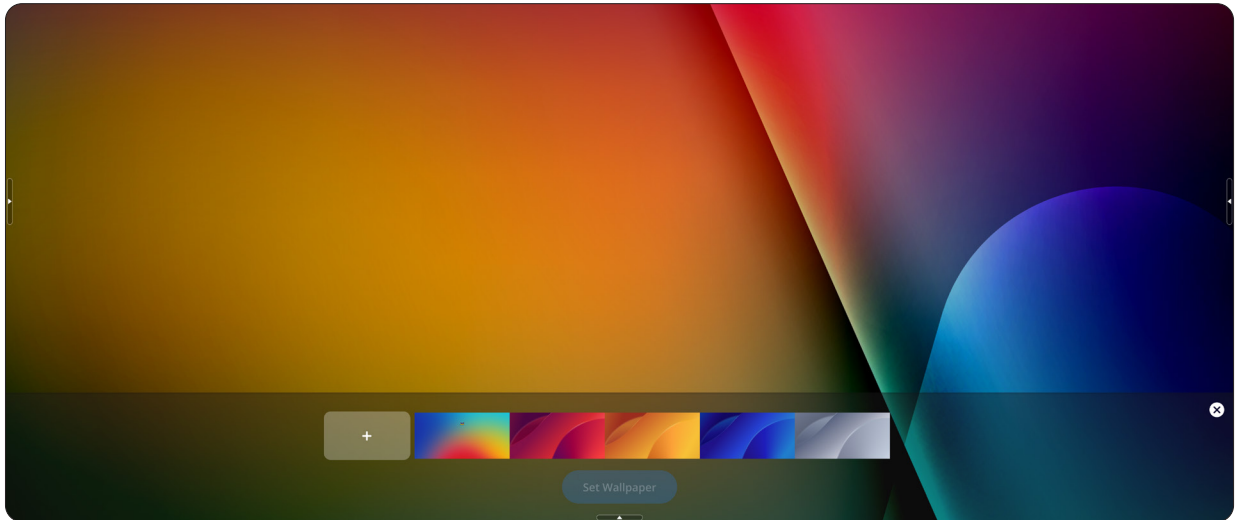

Protection

Set **HDCP & Copyright** on or off.

Protection

HDCP & Copyright

HDCP is a secure protocol for protecting transmission of audio and video signals.

HDMI Out

Adjust the HDMI Out Resolution setting, enable video output, and mute/unmute the display speaker when connected via HDMI Out.

NOTE: The disable ViewBoard speakers option box is not selected by default.

HDMI Out

HDMI-out resolution setting

3840X2160_60HZ

1920X1080_60HZ

720X480_60HZ

AUTO

HDMI IN OUT

It is necessary to plug and unplug the HDMI interface once to take effect.

Disable ViewBoard speakers when using HDMI out

Preferences

View and adjust Touch, Language, Keyboard & Input, Date & Time, Boot Mode & Advanced, Start up & Shut down, Toolbar, Multi-Window Mode, and Sound settings.

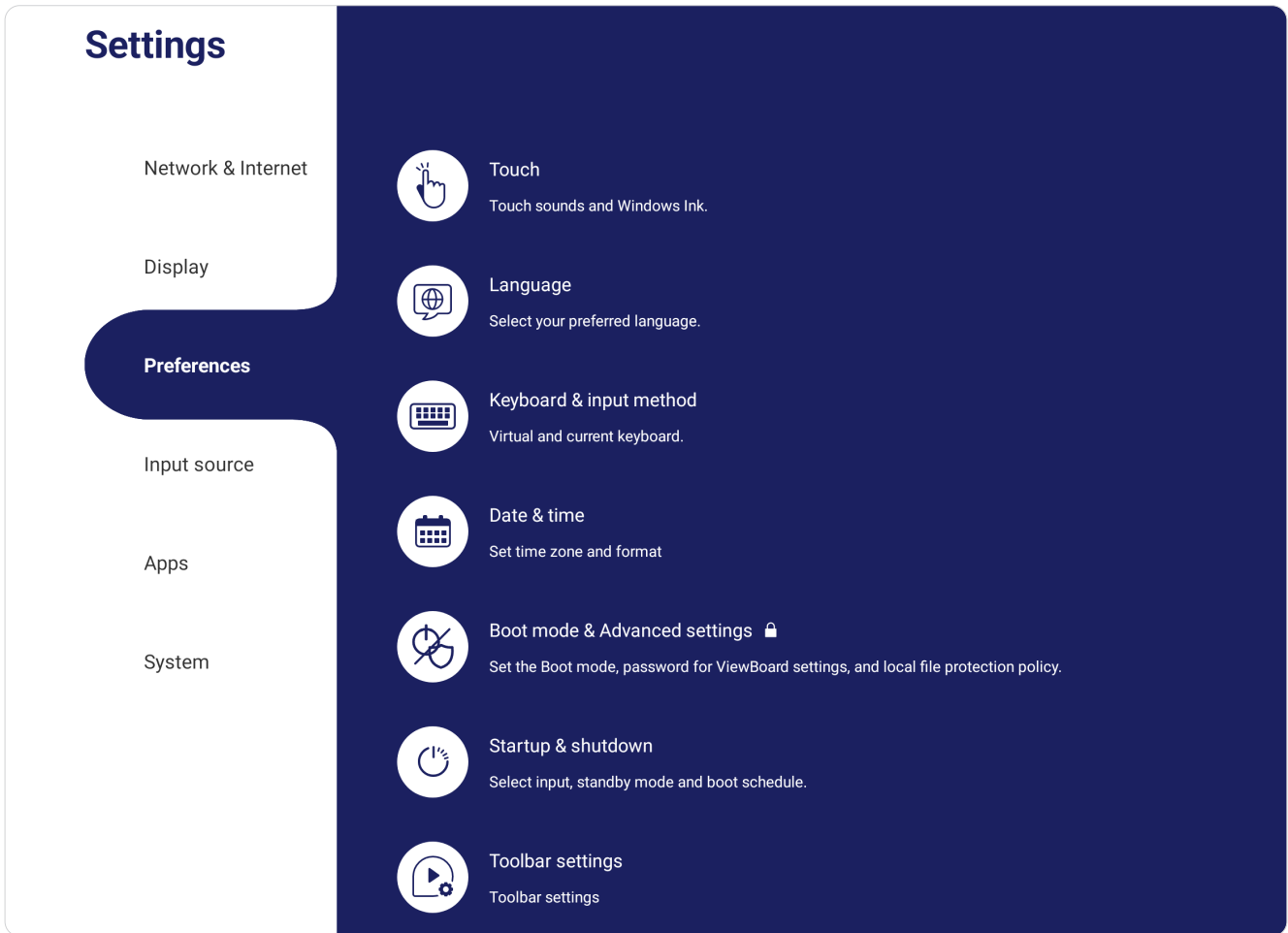

Touch

Adjust **Touch Settings** and toggle **Touch Sounds** and **Windows Ink** On/Off.



Language

Adjust and choose the preferred language from the available languages.

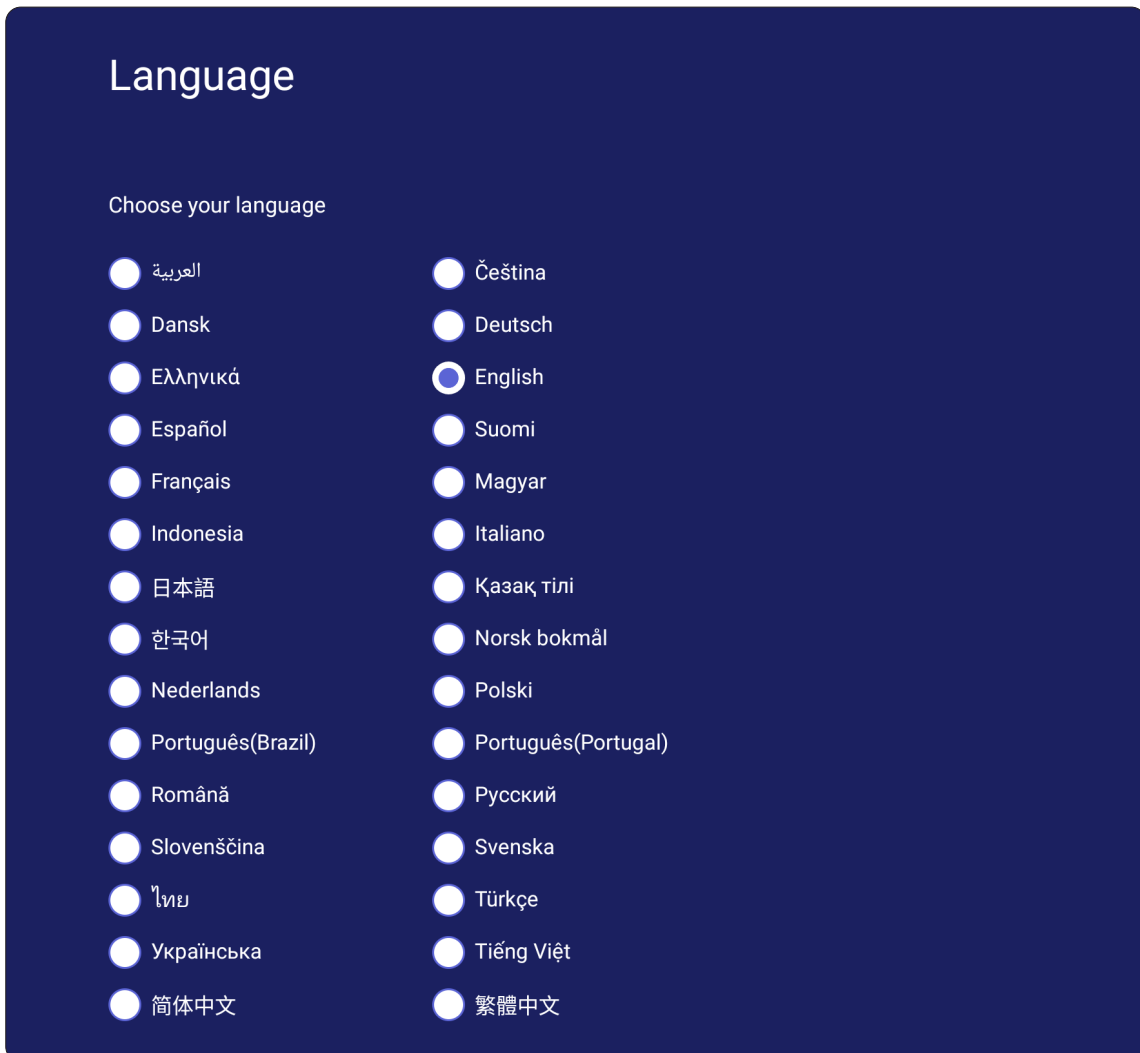

Keyboard & Input Method

Enable/disable the visual keyboard and/or change the default input method. Tap on **Settings** to adjust the advanced keyboard settings.

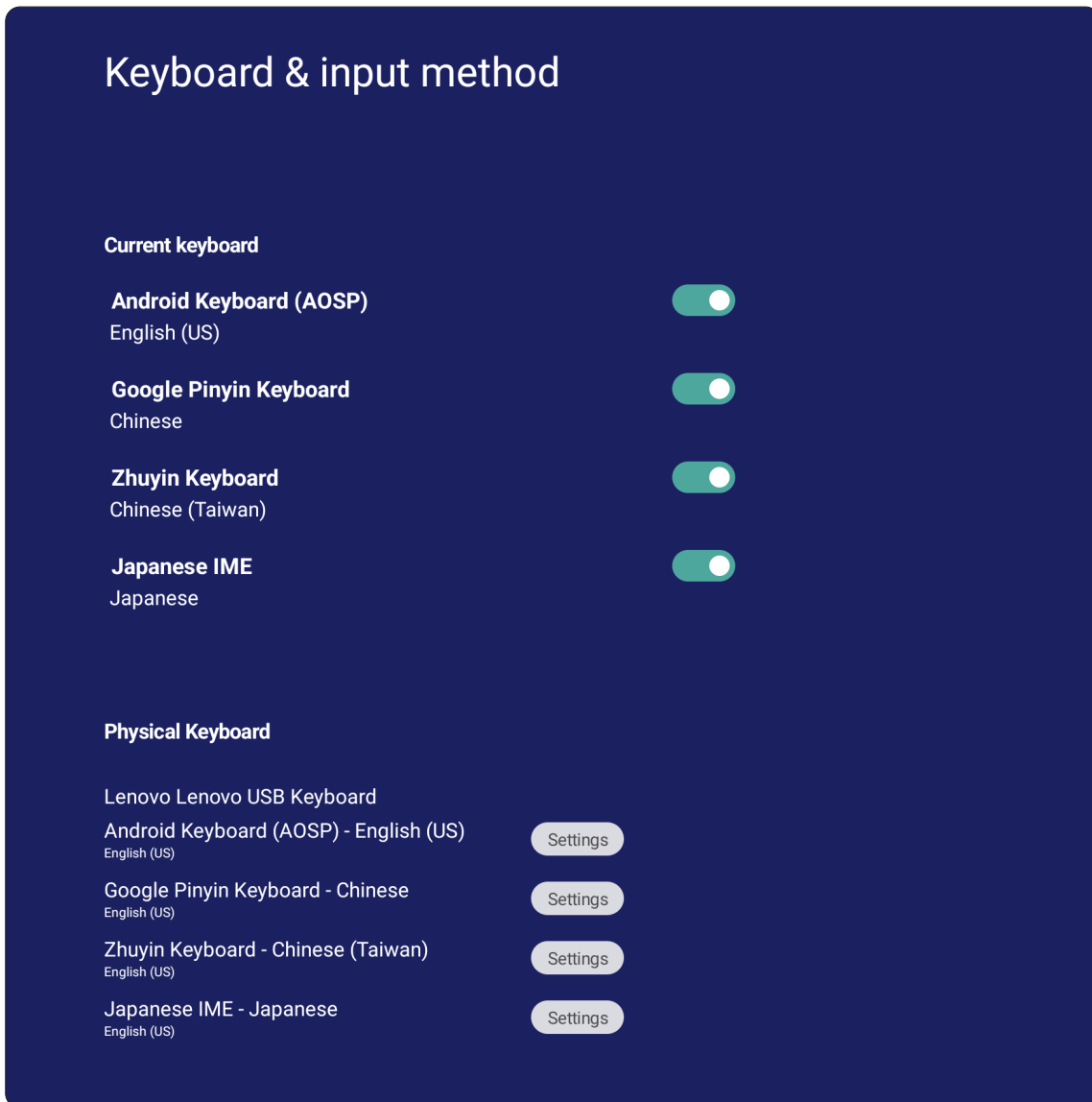

NOTE: When an external USB keyboard is connected, the menu will display the physical keyboard settings option.

Date & Time

Set the system time and format.

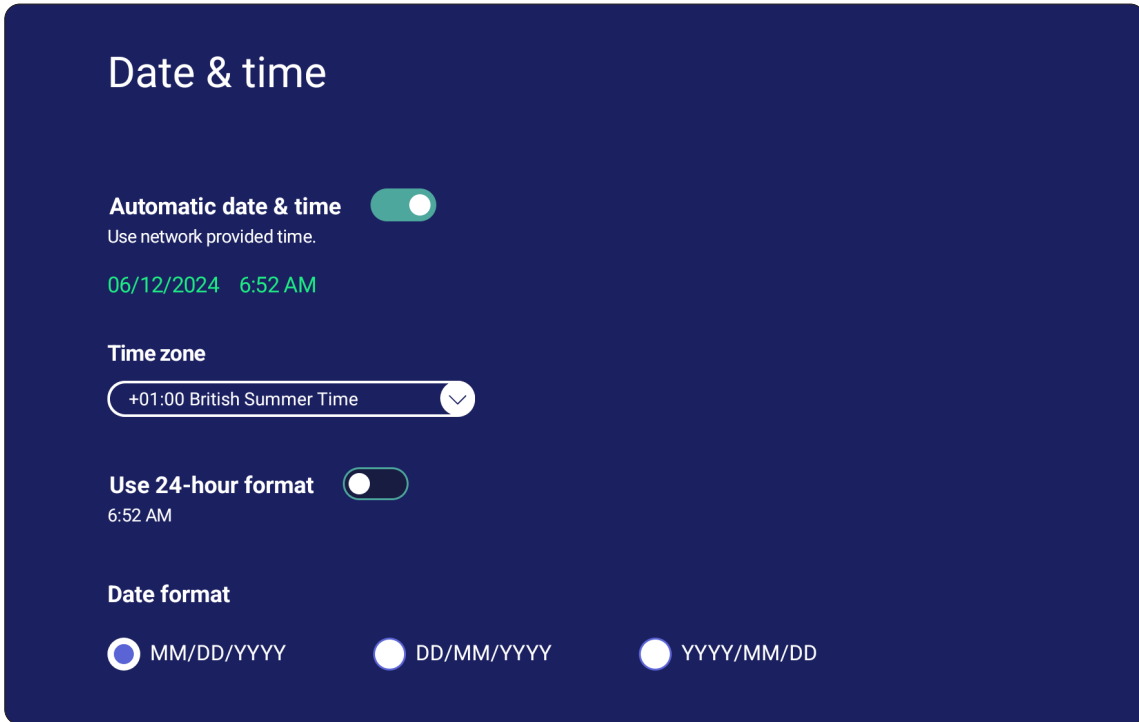

Item	Description
Automatic Date & Time	When enabled, the ViewBoard will automatically synchronize the date and time via the Internet.
Time Zone	Select the appropriate time zone.
Time Format	Choose from 12-hour or 24-hour time format. Simply toggle 24-hour format On/Off.
Date Format	Select from the available date formats.

Boot Mode & Advanced Settings

Adjust the preferred boot up mode and set/reset a password.

Boot mode & Advanced settings

- Normal mode**
 Launch startup programs, begin all services configured to start, and loads the hardware drivers you have installed as normal.
- Secure mode**
 Removes embedded screen sharing apps such as V-Cast, E-Airplay, and Chrome Cast.
- Disable embedded OS**
 The embedded OS will be disabled after reboot.

Enable password for ViewBoard settings

If enabled users will have to enter a password to open ViewBoard settings

Boot mode and advanced settings password Reset password

Local File Protections Policy

To protect personal files, the local storage file in Folder app will be deleted automatically at the time of your c

- Do not clear file(s)**
- Delete after 1 Day**
- Delete after 1 Hour**
- Delete immediately**

Color correction

- Monochromacy
- Deuteranomaly (red-green)
- Protanomaly (red-green)
- Tritanomaly (blue-yellow)

Non-ViewBoard OS mode side toolbar settings

Set side toolbar on/off for non-ViewBoard OS mode

Reset ViewBoard

Item	Description
Normal Mode	The embedded screen sharing Apps will run normally.
Secured Mode	The embedded screen sharing Apps will be removed.
Disable Embedded OS	The system will automatically reboot, and then the Embedded OS will not appear.

Item	Description
ViewBoard Settings Access Password	Toggle to lock/unlock the ViewBoard Settings.
Password for Protection	Modify the Boot mode and ViewBoard Settings entry password.
Local File Protection Policy	Choose how long to keep local storage files in the Folder application.
Color Correction	Color correct the ViewBoard display screen.
Reset ViewBoard	Reset the ViewBoard to its factory default settings.

Startup & Shutdown

Set the Startup Input, Standby Mode, EnergyStar Mode, Black Screen After Startup, Power off Reminder timer and Schedule settings.

Startup & shutdown

Startup input

Last shutdown input
 Select input
 ViewBoard ▼

Startup application N/A ▼

Automatically launch a specific application upon startup.

Standby mode

Hibernation
Hibernation Mode turns off the entire device including the display. To wake up, use the power button on the ViewBoard, the remote control, or use a compatible device via RS232.

Sleep
Sleep Mode turns off the display and major functions of the device. The operating system will remain running. Wake up the ViewBoard using the power button on the ViewBoard or the remote control, or use a compatible device connected via RS232.

Energy Star

After no action for one hour, device will enter standby mode as selected by the user (hibernate or sleep).

Black screen after startup

To conserve power, screen backlight will not turn on after startup.

Sign-in page launched upon system startup

Allows you to bypass the Sign-In page after the system is initiated.

Time switch

Power off reminder

Toggle Power off reminder

Schedule ADD SCHEDULE

Boot timeOff time

Item	Description
Startup Input	Adjust the Startup Input preference.
Startup Application	Automatically launch an application at startup.
Standby Mode	Decide what happens when you press the Power button while the ViewBoard is On.

Item	Description
Energy Star	Enable to automatically initiate Sleep Mode when the screen is idle for one hour.
Black Screen After Startup	When enabled, the ViewBoard will turn off the backlight automatically after booting up.
Sign-in Page Launched Upon System Startup	Choose to skip the Sign-in page after startup.
Schedule	Schedule a Boot and Shut off time.

Toolbar Settings

Adjust the Side toolbar settings.

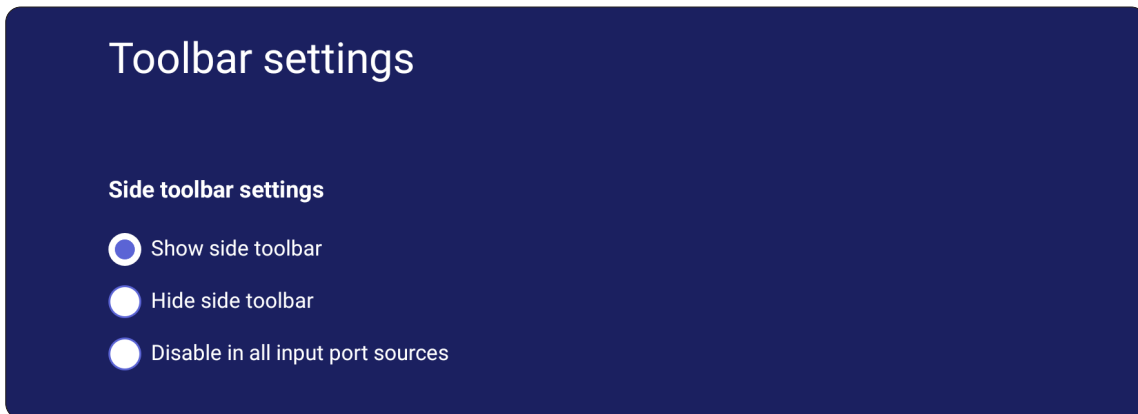

Multi-Window Mode

Display more than one app at the same time on screen when turned on.

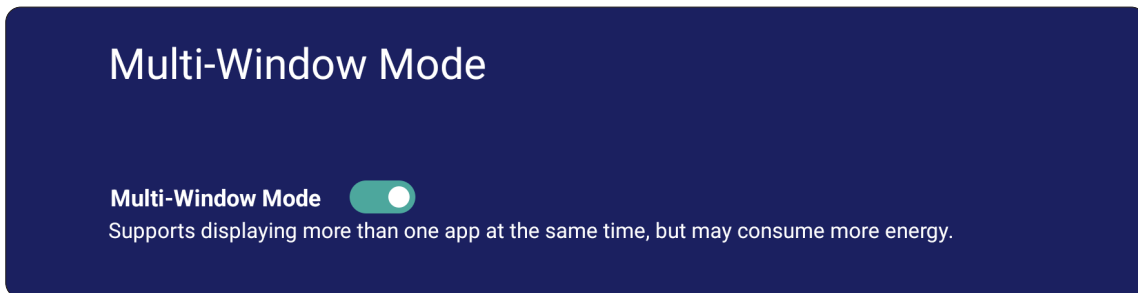

Sound Setting

Adjust Touch Sound Output Settings.

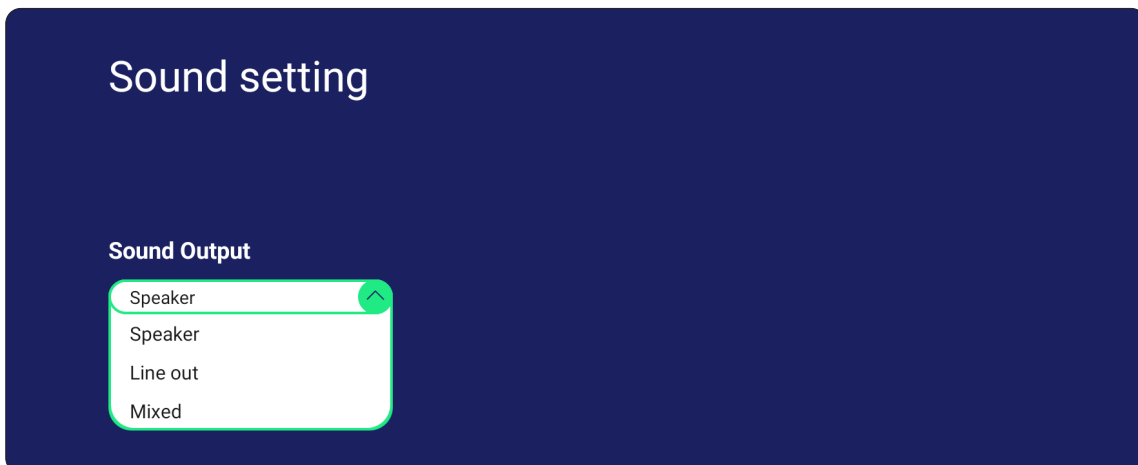

Input Source

Adjust the input source names and settings, as well as the side toolbar settings.

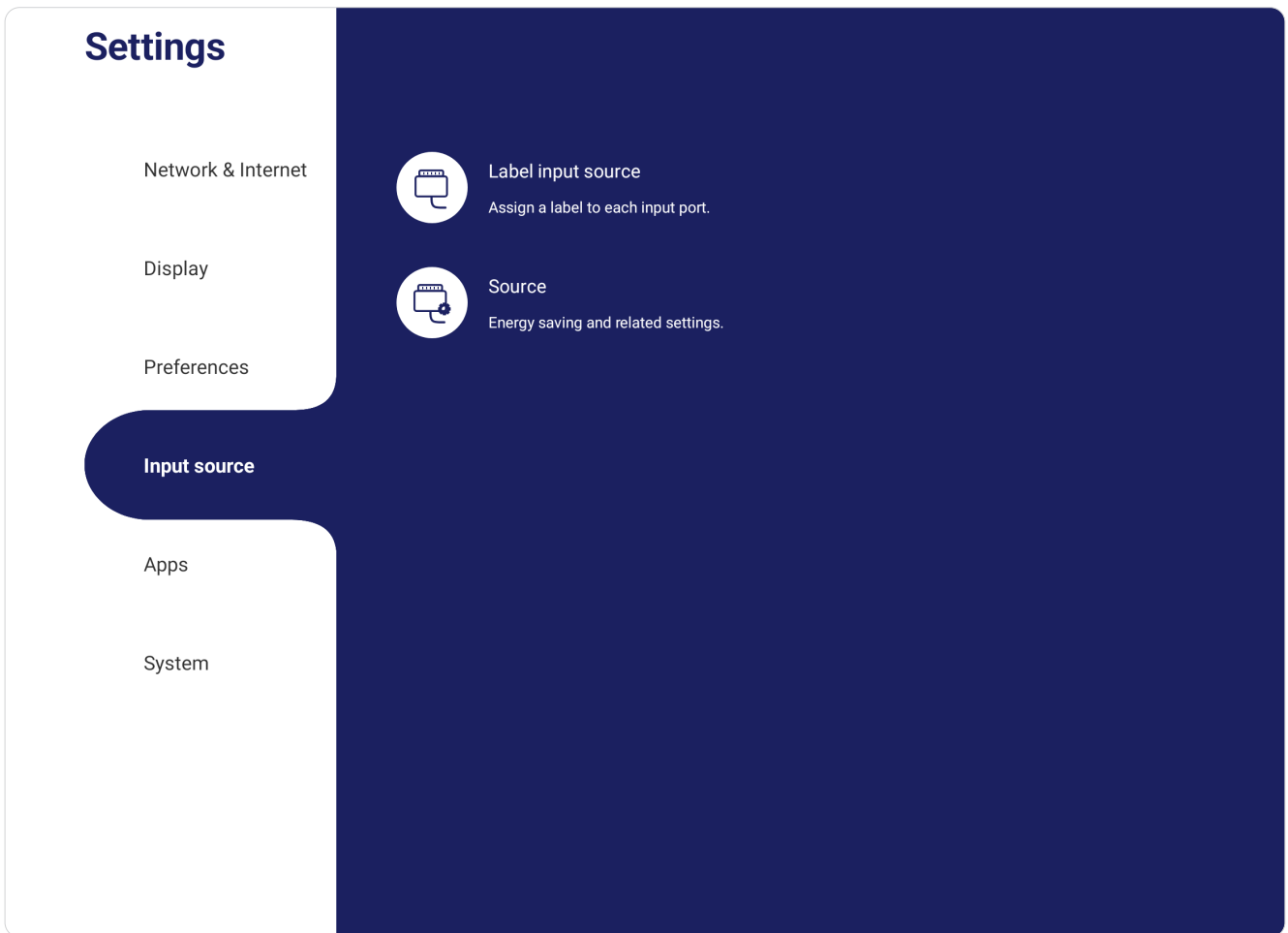

Label Input Source

Set labels for each input source that will be easily recognized when displayed.

Label input source

Add a label to help you recognize input ports easier.

Source	Label	
ViewBoard	ViewBoard	
HDMI 1	HDMI 1	<input checked="" type="checkbox"/>
HDMI 2	HDMI 2	<input checked="" type="checkbox"/>
HDMI 3	HDMI 3	<input checked="" type="checkbox"/>
HDMI 4	HDMI 4	<input checked="" type="checkbox"/>
DP	DP	<input checked="" type="checkbox"/>
TYPEC 1	TYPEC 1	<input checked="" type="checkbox"/>
TYPEC 2	TYPEC 2	<input checked="" type="checkbox"/>

Source

Toggle Wake up by active HDMI input, Auto search signal, and HDMI CEC and select Auto switch input ports, Energy saving, and OPS 5K detect preferences.

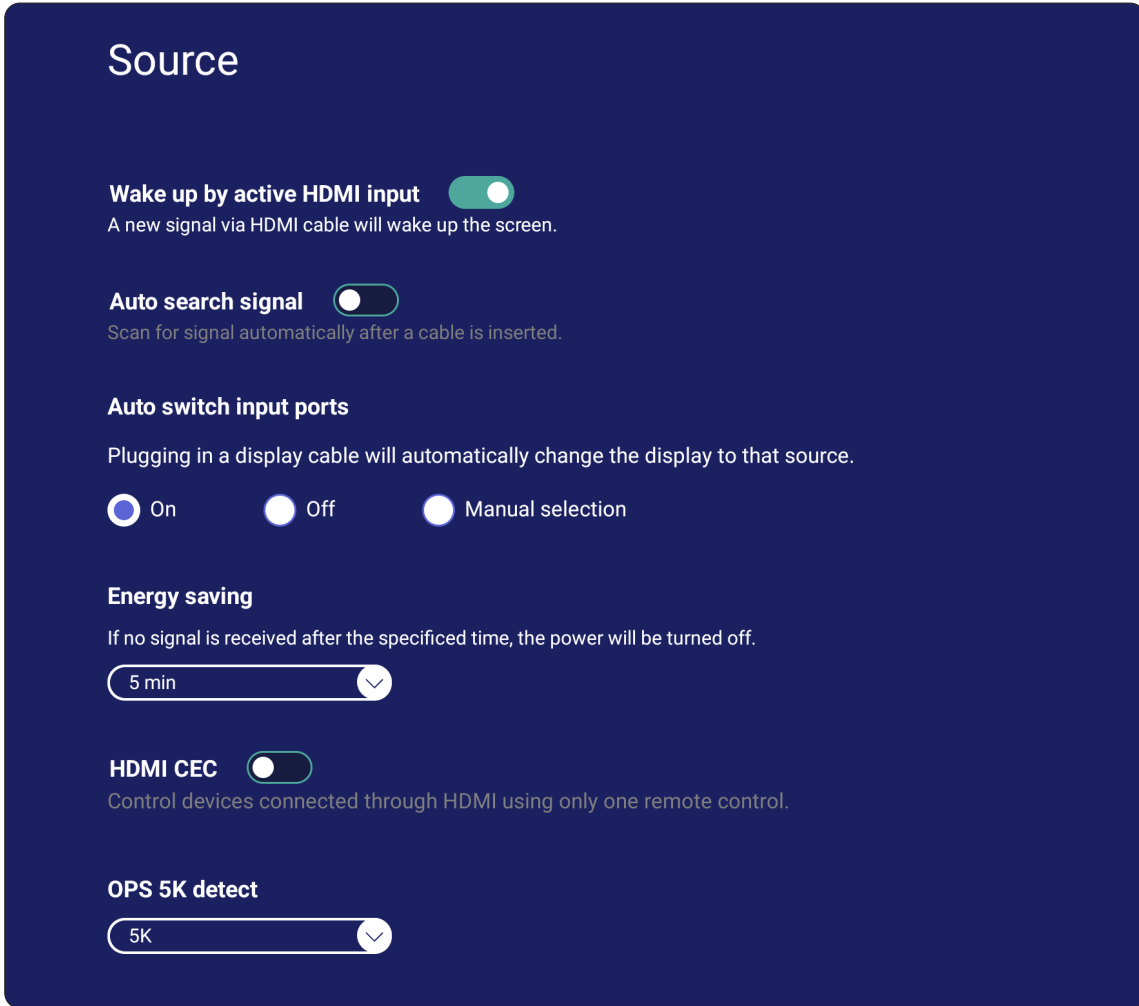

Item	Description
Wake Up by Active HDMI Input	The screen will turn on automatically after plugging in an HDMI cable when the screen is off.
Auto Search Signal	When enabled, if the current source does not have a signal, the ViewBoard will automatically search for an input source.
Auto Switch Input Ports	The original signal will automatically switch to a new cable after it's plugged in.
Energy Saving	Set a time period to power off if no signal is detected.
HDMI CEC	Enable/disable HDMI CEC functions.
OPS 5K Detect	Set OPS support resolution. NOTE: Please confirm the resolution supported by OPS and select the corresponding resolution option, otherwise there may be a situation where it cannot be displayed.

Apps

The user can view application information and force stop, uninstall, move to USB storage, clear data, clear cache, and clear defaults.

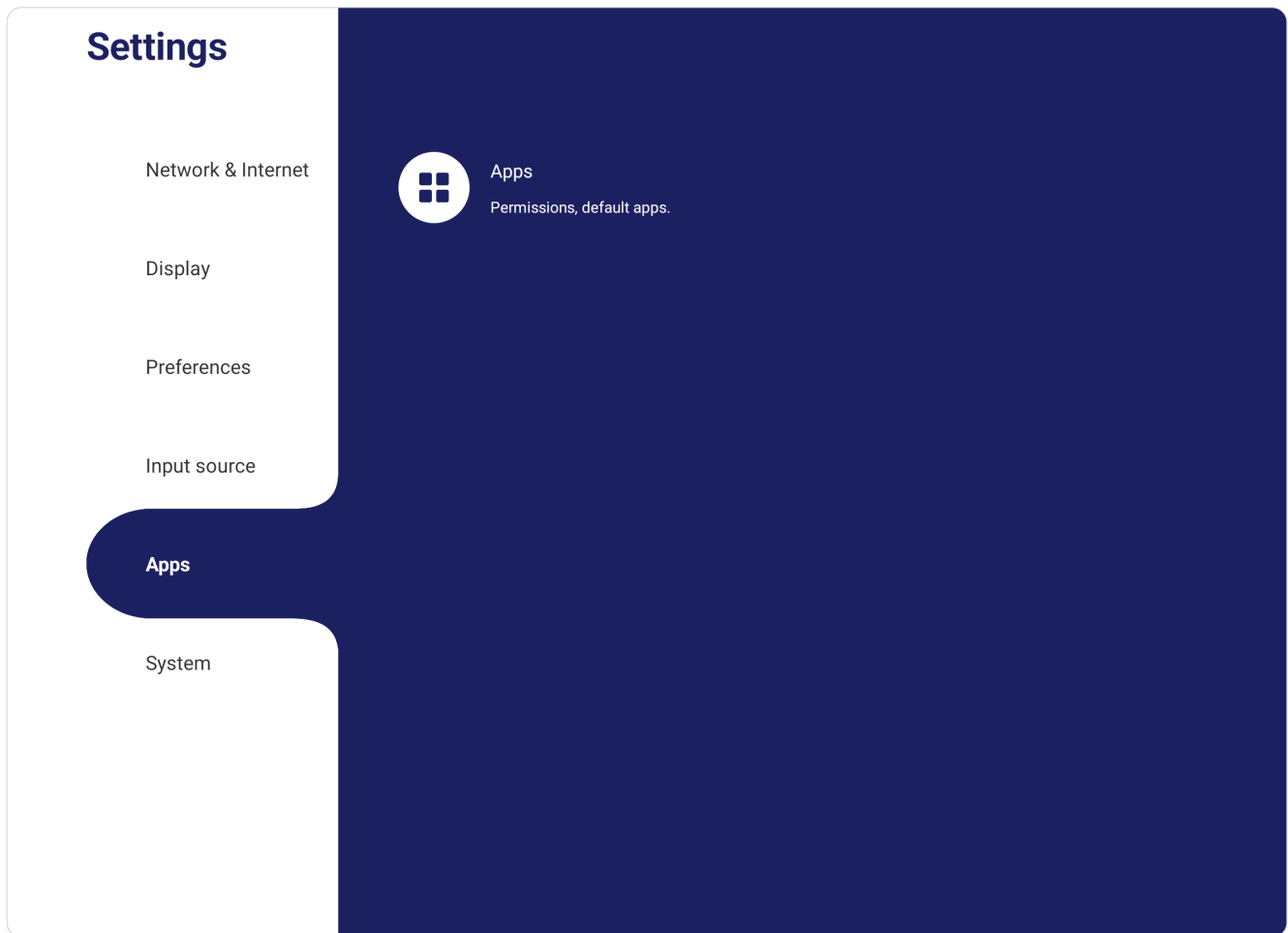

NOTE:

- Pre-loaded apps cannot be uninstalled.
- Not all apps support the move to USB storage feature.
- Not all apps support Clear Defaults.

Apps

View any running or installed applications. Tap on them for more detailed information and options.

The screenshot shows the 'Apps' settings page with three tabs: 'Running' (selected), 'All', and 'Downloaded'. Below the tabs, there is a 'Device memory' section showing a progress bar for '18 GB of 64 GB ROM storage used'. A legend indicates 'App (app data & media content)' at 19 MB and 'System' at 18 GB. The 'App RAM usage' section lists four applications with their RAM usage, process/service counts, and toggle switches. A 'Sort by name' toggle is currently OFF.

App Name	RAM Usage	Process/Service	Time	Toggle
Mobile Network Configuration	1.1 MB	1 process and 0 service	01:10:05	OFF
myViewBoard Manager	0.4 MB	1 process and 1 service	01:04:59	ON
vlauncher	0.4 MB	1 process and 1 service	01:14:47	ON
myViewBoard	0.3 MB	1 process and 0 service	01:04:59	ON

- By tapping on a running application, you can see more information, stop, or report the application.

- Selecting **All** will list all installed applications.

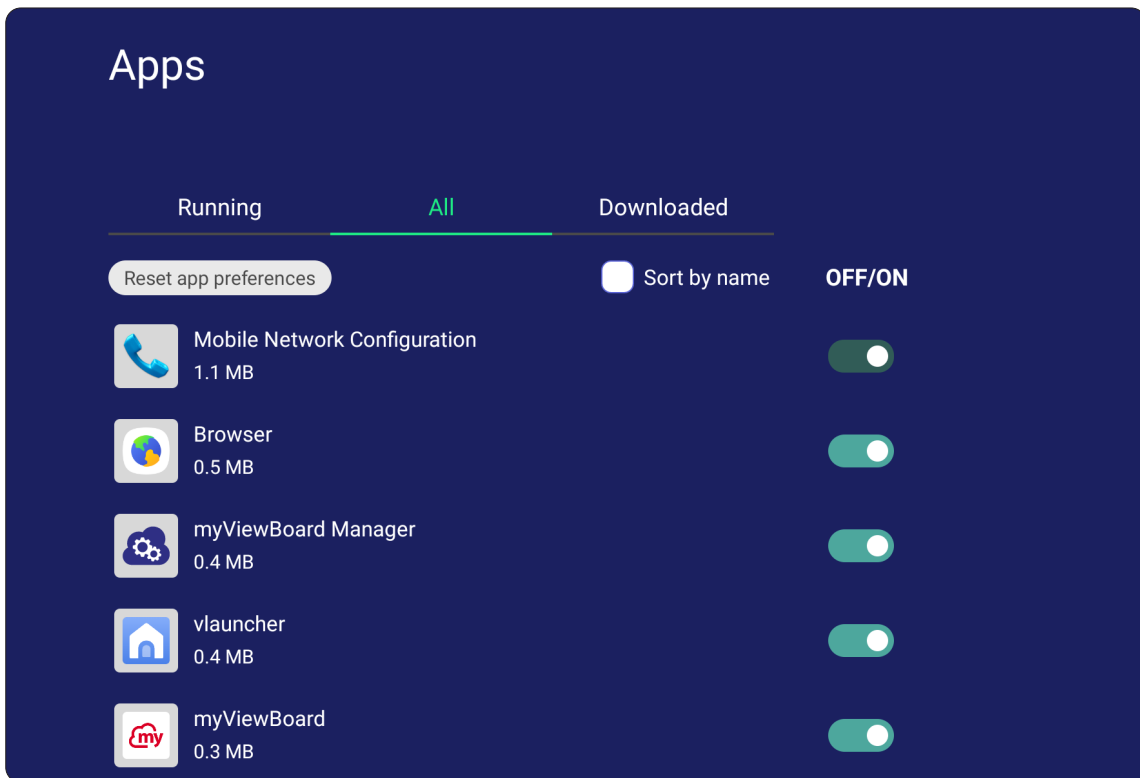

- Tapping on any application will display further information and options.
- Selecting **Download** will list all installed applications that can be uninstalled.

System

View and adjust Storage, Clone to USB, Display ID, Security, System Update, and About device settings.

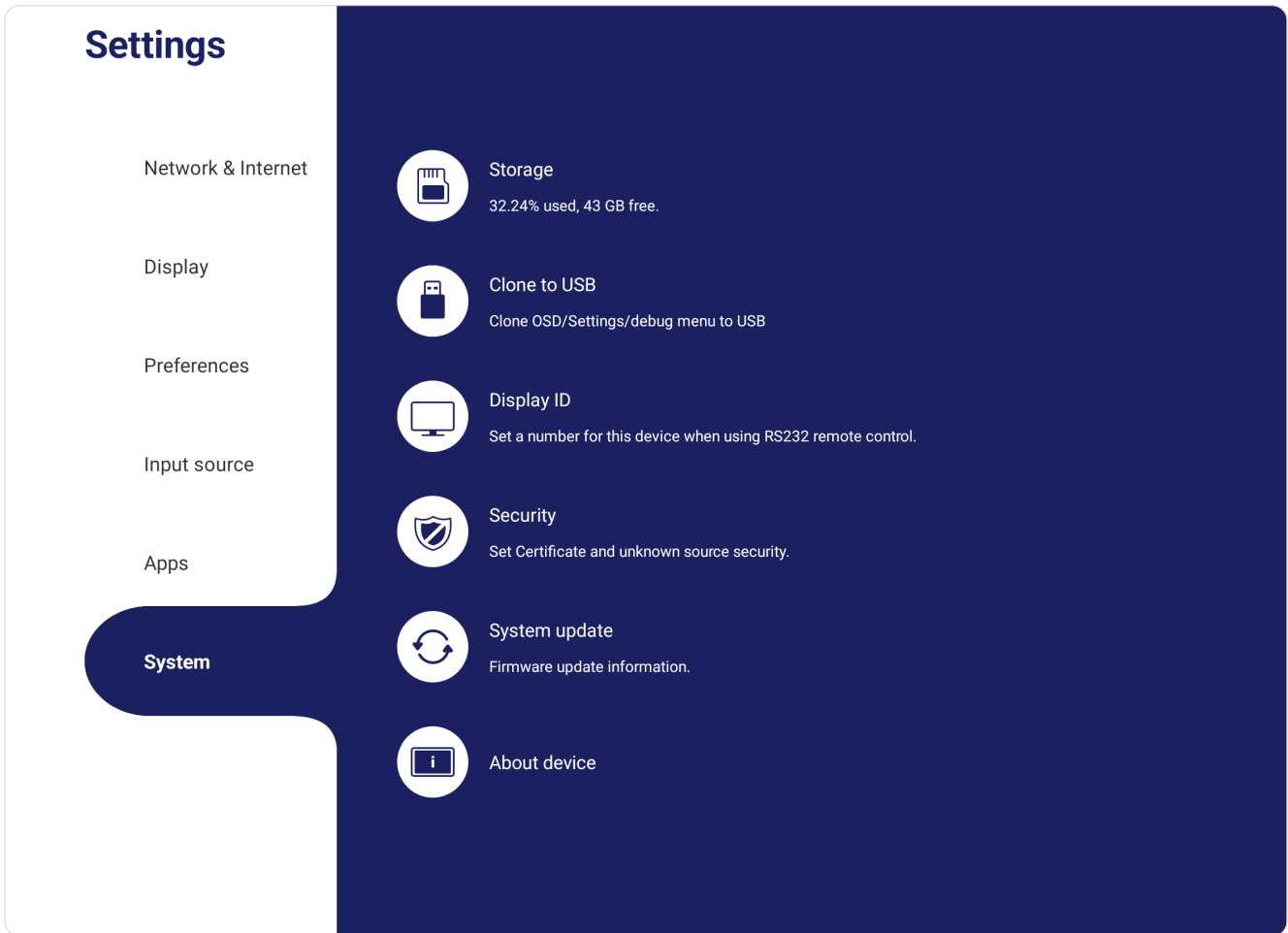

Storage

Check the storage space status of the display (internal) and any connected external storage devices.

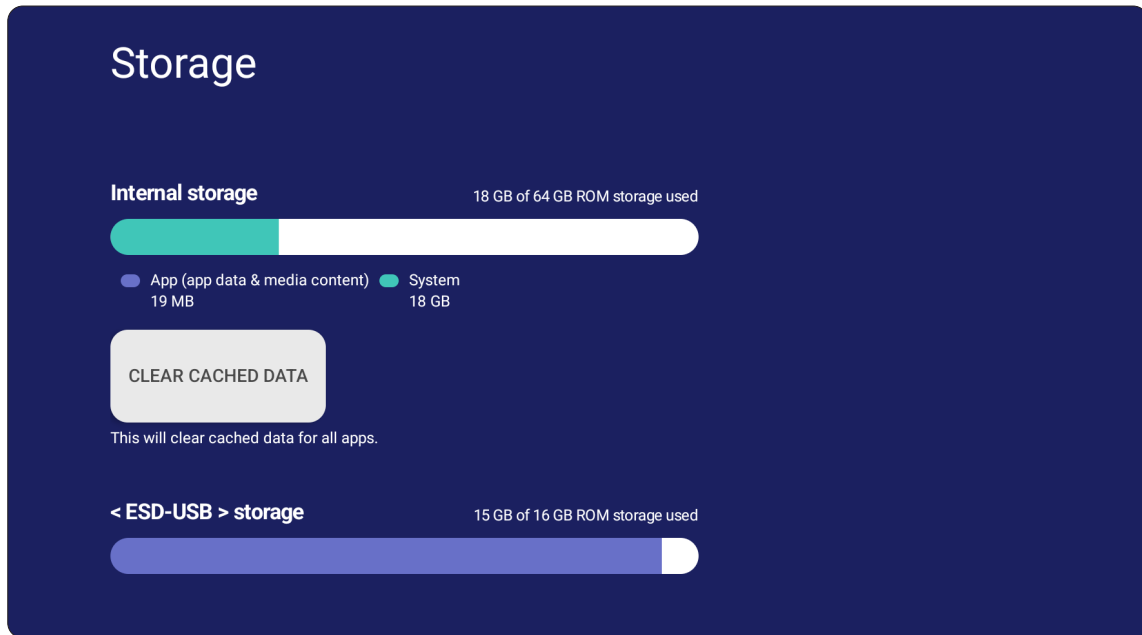

Clone to USB

Copy settings to an external USB drive.

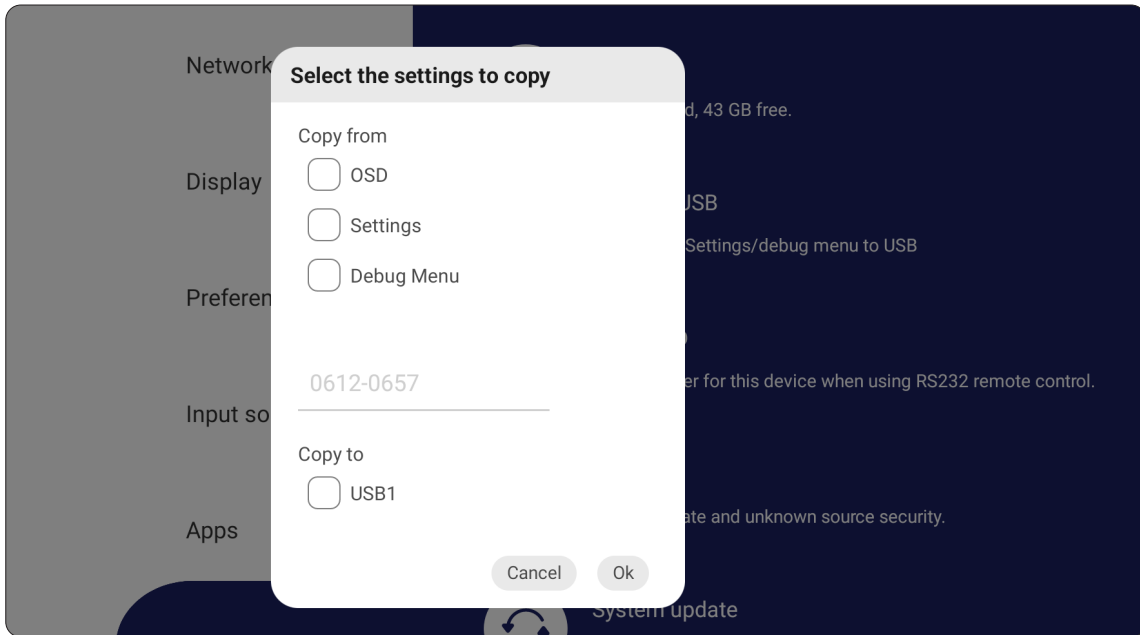

Display ID

Assign a number to remote control the display by RS-232.

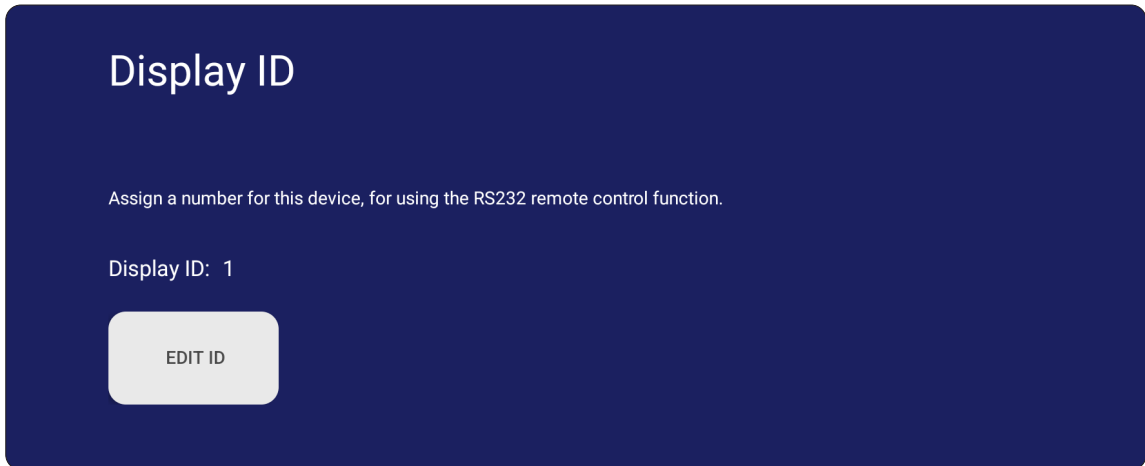

- To assign or change the Display ID, tap **Edit ID** and input a number.
NOTE: The Display ID is for RS-232 users, and the range is 01~98.

Security

Review Certificates, Trusted Credential storage, and Unknown sources install settings.

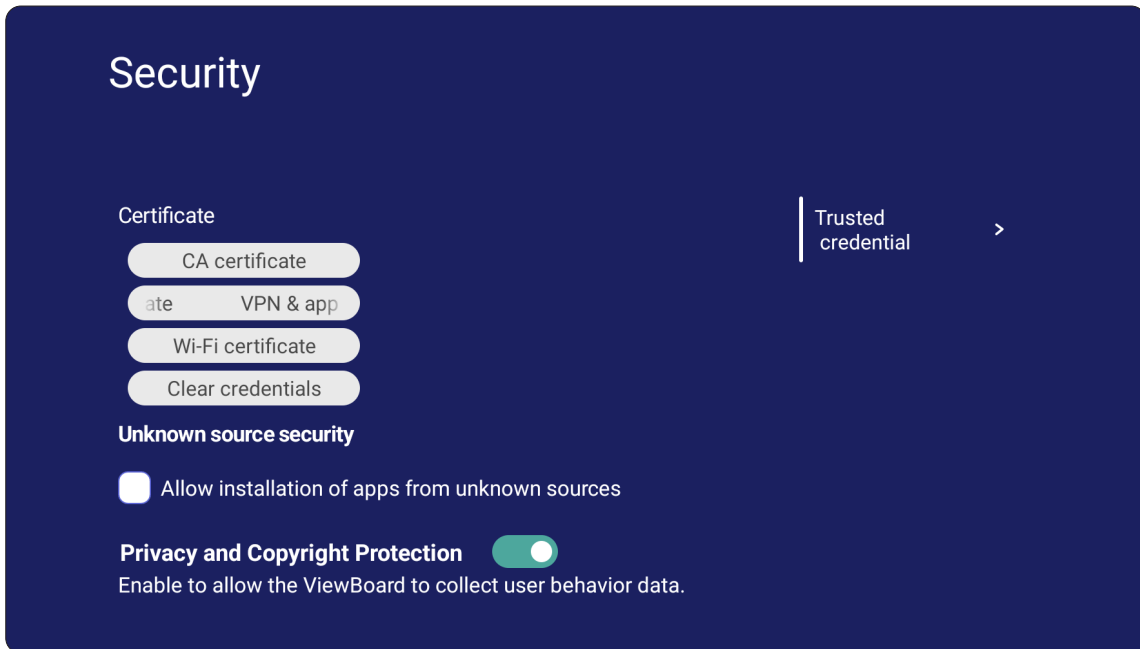

- Tap on **Install certificate from storage** to add additional certificates.
- Selecting **Clear Credentials** will remove all manually installed credentials.
NOTE: Pre-loaded credentials cannot be cleared.
- Under **Trusted Credentials** view and edit all trusted and installed CA certificates.

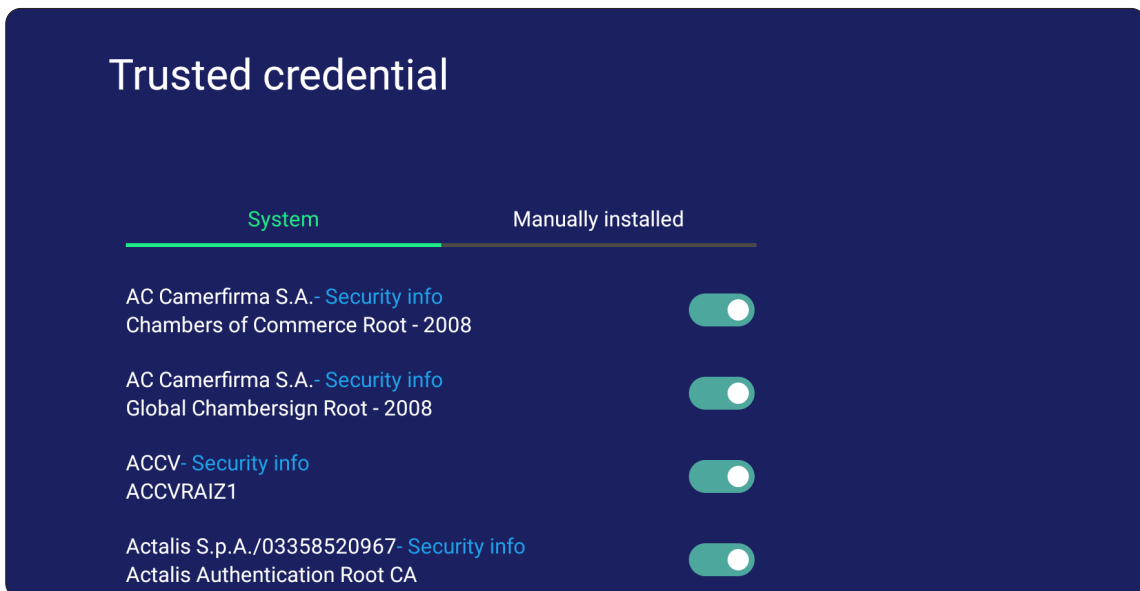

- Tapping on a credential will provide more detailed information.

- Allow the installation of applications from unknown sources by selecting the box under **Unknown source security**.



NOTE: Applications from unknown sources may not be compatible or work properly.

System Update

The ViewBoard automatically searches for software updates whenever connected to the Internet (OTA). With just one click, users can update their version of ViewBoard software.

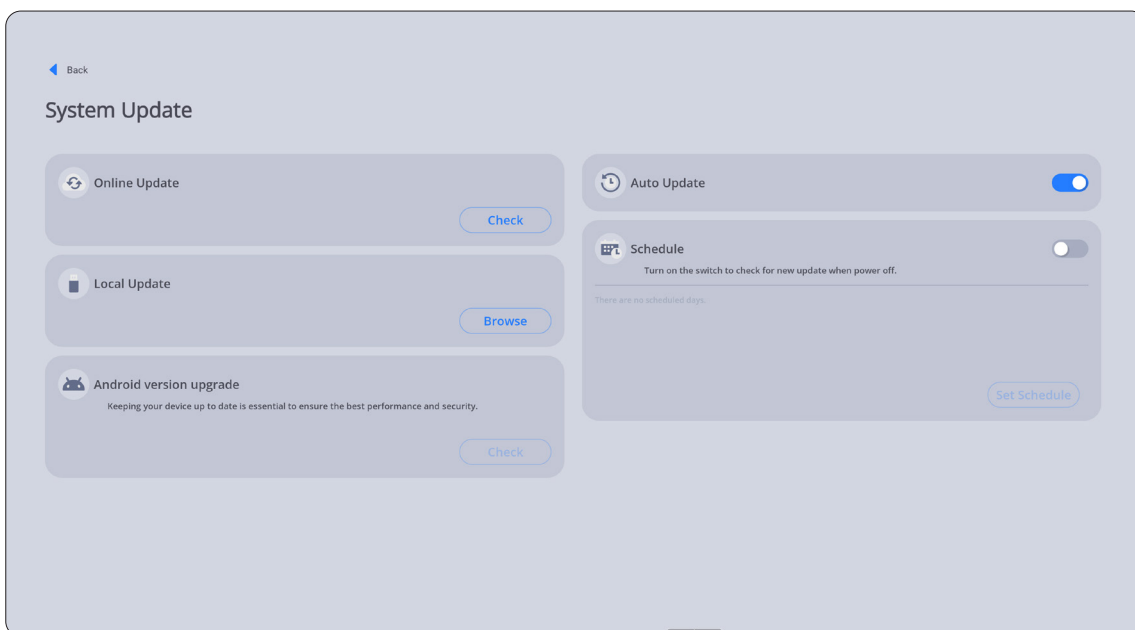

Item	Description
Online Update	Manually check online for a new software version.
Local Update	Update the software manually with a local file.
Android Version Upgrade	Manually check for a new Android version.
Auto Update	When the display is off, the system will automatically check for a new version. If a new version is found, the system will automatically update. After the update is complete, the system will turn off.
Schedule	Set the update time.

About Device

Display Embedded Player information, Legal information, and Asset Tagging.

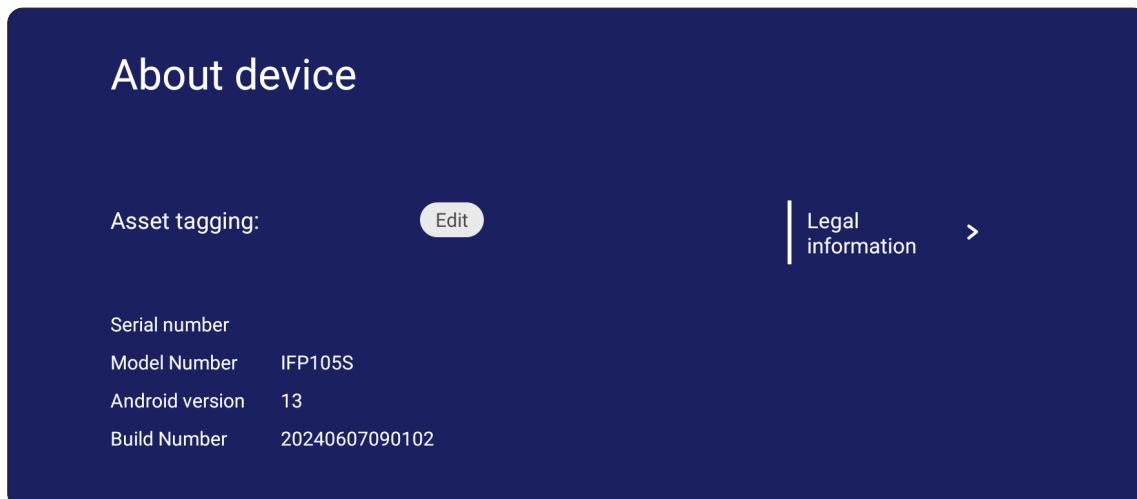

- By selecting **Edit**, the asset information can be adjusted.
- Tap on **Legal information** to check open source licenses.

Pre-installed Applications and Settings

NOTE: Installed applications are subject to change (install, uninstall, update) without notice when the system is updated. Please contact your local customer service if you have any questions.

myViewBoard

A digital whiteboarding application.

NOTE: To learn more about myViewBoard Whiteboard, visit:



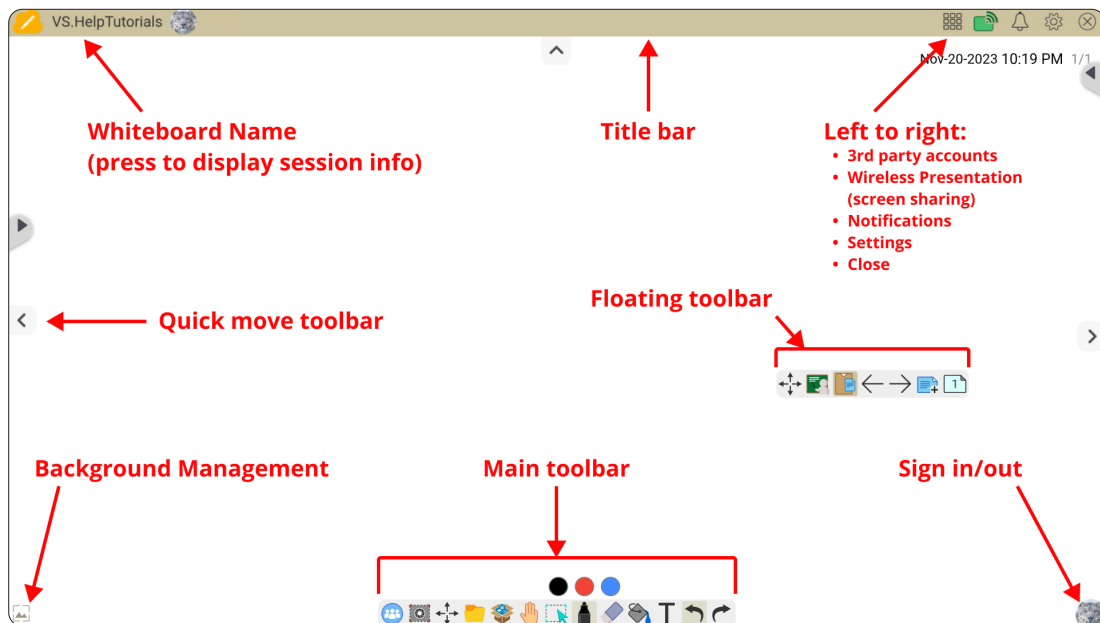











<https://myviewboard.com/kb/getting-started-whiteboard/overview-whiteboard>.









Floating Toolbar

Item	Description
	Move Move the Floating Toolbar.
	Present Mode Switch between presentation and preparation modes.
	Paste from Clipboard Insert the current clipboard content onto the canvas.
	Previous Page Go to the previous page (if the canvas has multiple pages).
	Next Page Go to the next page (if the canvas has multiple pages).
	New Page Add a new canvas.
	Pages in Whiteboard Create, select, rearrange, copy and delete pages.

Main Toolbar

	Item	Description
	Wireless Presentation	Enable and manage wireless presentations by casting your session to other devices or receiving a feed from other devices.
	Screen Capture	Screenshot, video, and audio recording.
	Move	Select and hold to move the toolbar to the left side, right side, or bottom of the screen.
	File Manager	Open, save, export, and print whiteboard files.
	Magic Box	Import resources (image, video, audio, etc.) to the whiteboard.
	Embedded Browser	Open the built-in browser to access internet resources, which can be dragged onto the canvas.
	Infinite Canvas	Drag to move the canvas. Use two hands to zoom in/zoom out. Select again for an overview.
	Selection Tool	Select objects, text, and other elements on the canvas.
	Pen	Writing tools and customization options.
	Eraser	Erase objects or clear the page.
	Shapes and Lines	Draw shapes, arrows, and add tables.
	Text	Add a text box.
	Undo	Undo the previous action.
	Redo	Redo the previous action.

Background Management

Item		Description
	Sign In	Sign in to a myViewBoard account.
	Background Management	Change the canvas background.
	FollowMe Setting	Display custom images uploaded to a cloud storage account.
	Color Palette	Choose from solid or gradient colors as the background.
	Pre-installed	Choose backgrounds that come pre-installed with Whiteboard.
	myViewBoard Originals	Display original content created by myViewBoard.
	Local Hard Drive	Use images from the local hard drive.

Screen Recorder

Capture everything that is displayed on screen in a video format.



To launch the Screen Recorder application:

1. Select the Screen Recorder icon in the application drawer.
2. Tap the record icon and select the preferred recording configurations. Then tap the check mark.

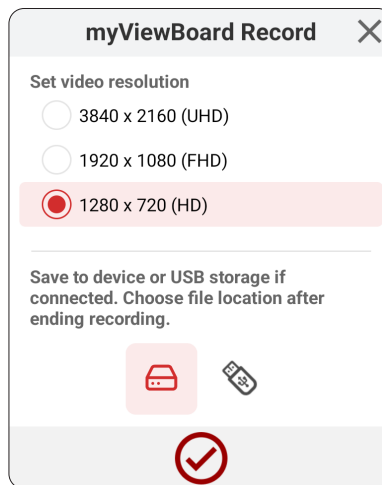

3. Select *Start Now* and a three second countdown will begin. Screen recording will begin immediately after the countdown.
4. After stopping the recording, you will be able to preview the video, save it, or discard it.

vCast

Working with ViewBoard® Cast software (vCast, vCast Pro, and vCastSender), the vCast application will allow the ViewBoard to receive laptop screens (Windows/Mac/Chrome) and mobile (iOS/Android) users' screens, photos, videos, annotations, and camera(s) that are using the vCastSender application.

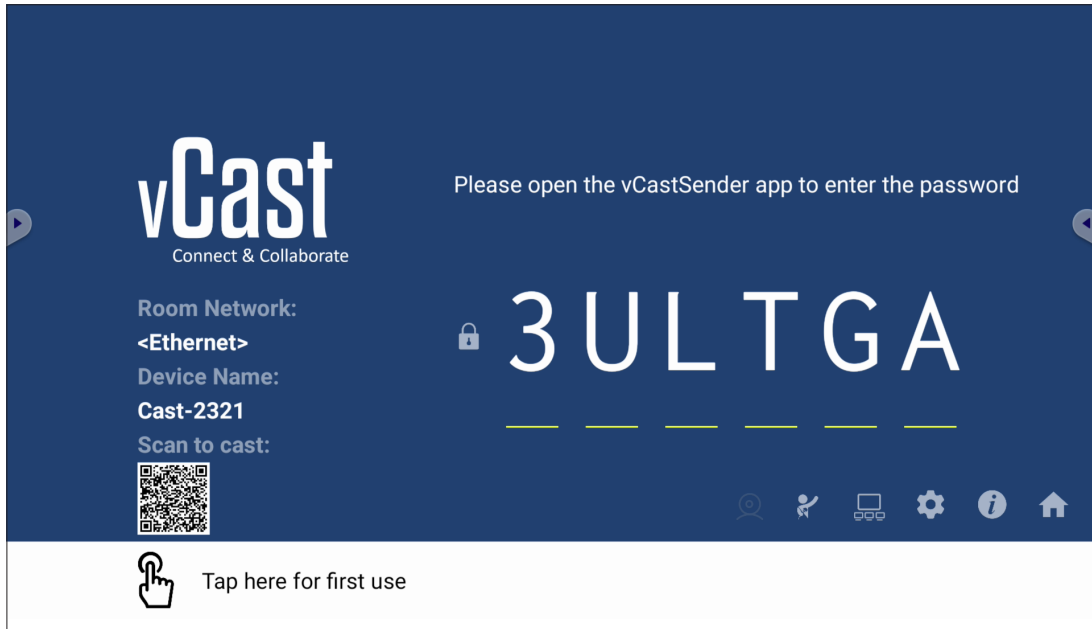

Network Information

- ViewBoard® Cast software, laptops, and mobile devices can connect to both the same subnet and cross subnet by entering the on-screen PIN code.
- Connected devices will show up under **Device List** on the same subnet connection.
- If the device does not show up under **Device List**, users will need to key-in the on-screen PIN code.
- **Ports:**
 - » TCP 56789, 25123, 8121 & 8000 (Controlling message port & client device audio transfer)
 - » TCP 8600 (BYOM)
 - » TCP 53000 (Request share screen)
 - » TCP 52020 (Reverse control)
 - » TCP 52025 (Reverse control for ViewBoard Cast Button)
 - » TCP 52030 (Status sync)
 - » TCP 52040 (Moderator mode)
 - » UDP 48689, 25123 (Device searching and broadcast & client device audio transfer)
 - » UDP 5353 (Multicast search device protocol)
- **Port and DNS for Activation:**
 - » Port: 443
 - » DNS: <https://vcastactivate.viewsonic.com>
- **OTA Service**
 - » Server Port: TCP 443
 - » Server FQDN Name: <https://vcastupdate.viewsonic.com>

Display Group Settings

To adjust the Display Group Settings, select the Display Group icon (🖥️) located in the lower-right corner of the screen.

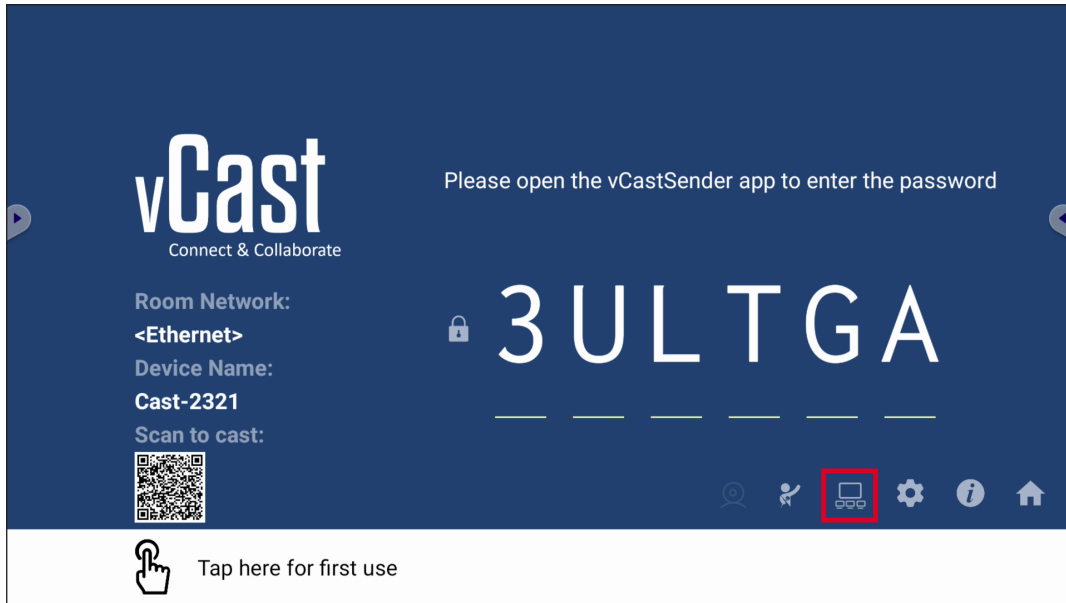

1. Toggle the “Turn On/Off Display Group” ON to enable the Display Group feature.

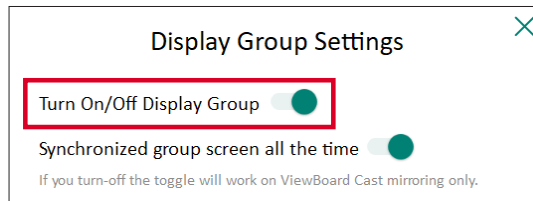

NOTE: Other preinstalled ViewBoard Cast devices in the same network will be listed.

2. Select the devices you want to join the display group and select **OK** to save the settings.

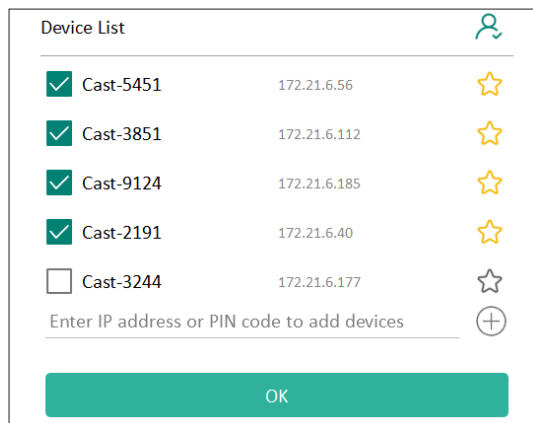

NOTE:

- If the devices you want to group are not listed, you can enter their respective IP address or connecting PIN code.
- The Display Group maximum device limit is six devices.

3. If you frequently connect to the same device, you can select the Star icon (★) next to the device to add it to your frequently connected devices list, “My List of Devices in Group”, for easier Display Group setup and management.

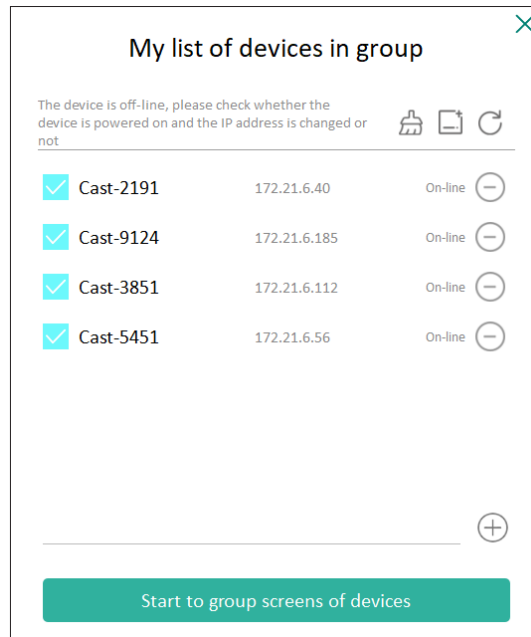

Synchronized Group Screen All the Time

When the “Synchronized group screen all the time” function is toggled ON, it will display a synchronized group screen continuously. If it is toggled OFF, it will work on vCast mirroring only.

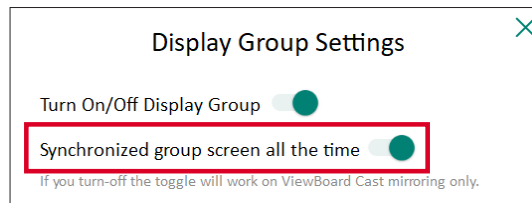

NOTE: Select the devices to group first, then toggle the “Synchronized group screen all the time” function ON to avoid interruption.

Share a Screen to the Display Group (One to Many Casting)

After confirming the above settings, you can share your screen to the main display, then the grouped client devices will be synced up to your screen.



Moderator Mode

Moderator Mode allows the moderator to take control of the devices connected to the ViewBoard or display. To enter Moderator Mode, select the Moderator Mode icon (👤) located in the lower-right corner of the screen.

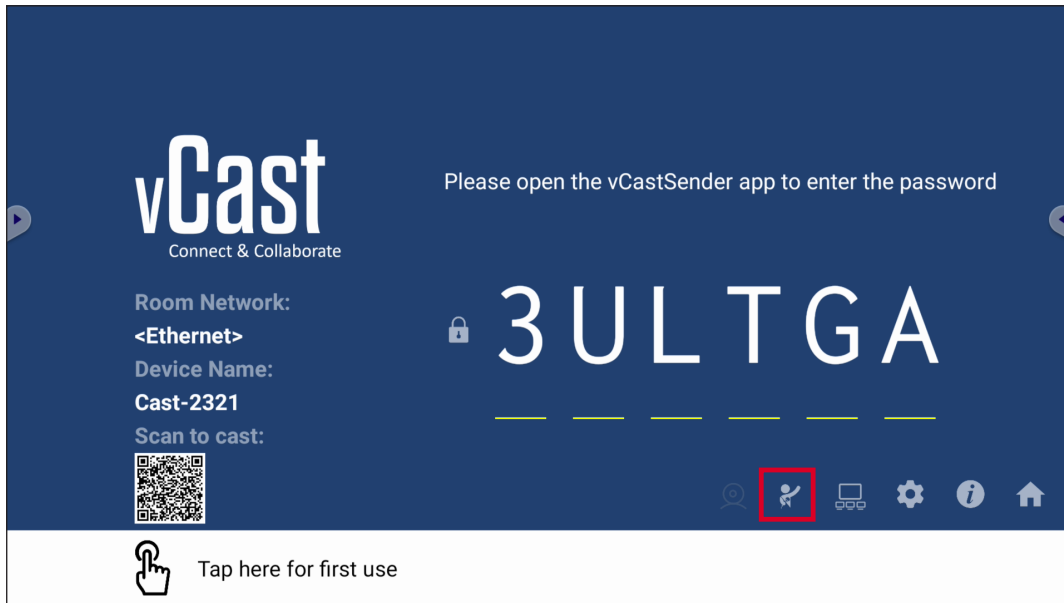

When enabled, the moderator can view a list of all connected screens in the left floating window and can preview each participant's screen and then select any of participant's screen and cast to the ViewBoard's or display's main screen for presentation. The moderator can also control each participant's screen, annotate on the ViewBoard or display, and remove unwanted participants by selecting the close icon (X).

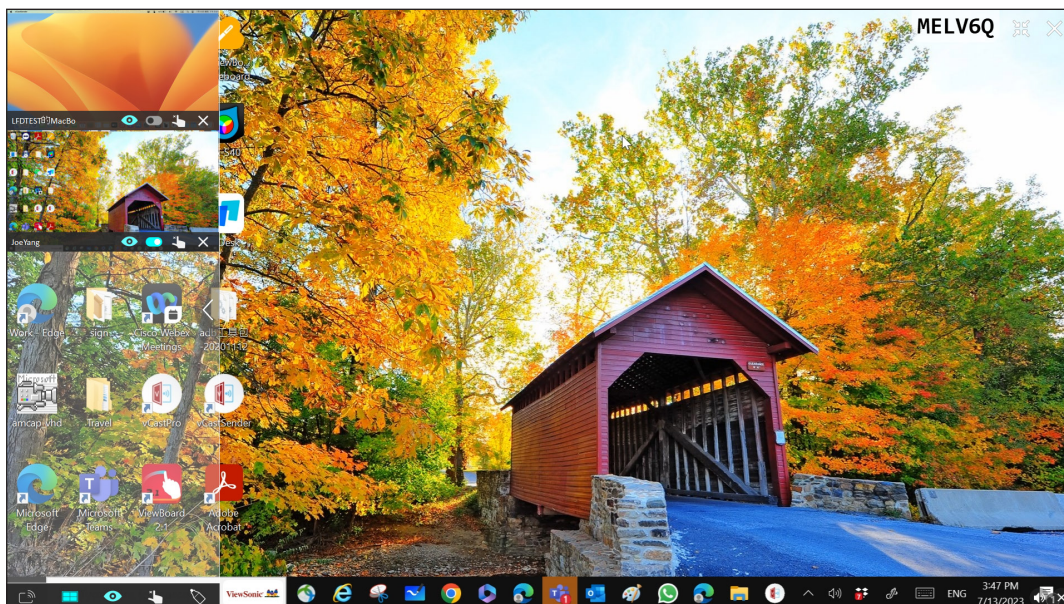

Broadcast

When enabled, the ViewBoard's screen will be broadcasted to all of the participant's connected screens simultaneously. The participants can only view the presentation contents until the moderator disables the Broadcast function.

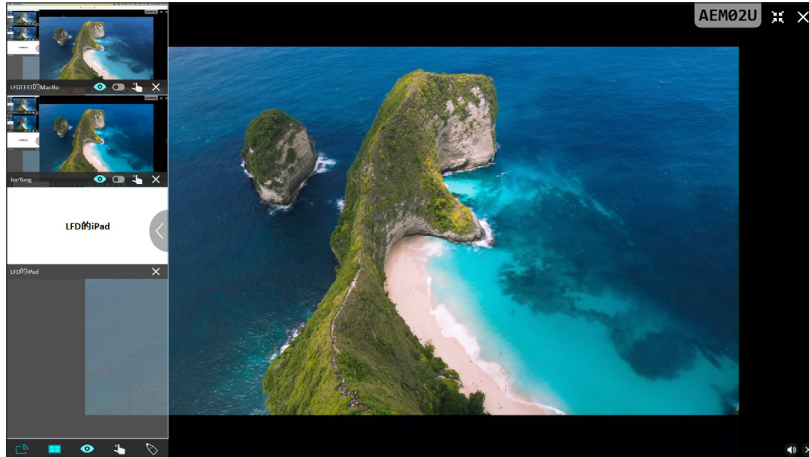

Multiple Screen Sharing

By default, vCast is set to allow multiple screen sharing, but can also be set to single screen sharing. To do this, the moderator can select the Multiple Screen Sharing icon to switch to single screen sharing.

Preview Screen

By default, vCast is set to let the moderator preview the participant's screen contents prior to sharing to the ViewBoard. Selecting the Preview Screen icon, the Moderator can switch to see the participant's name only.

Touch

By default, participants can use touch for collaboration after connecting. The moderator can enable/disable the touch function of a participant by selecting the Touch icon in their window.

NOTE:

- Moderator Mode is supported on all vCastSender and AirPlay devices, but mobile devices are limited to a “preview” function. Additionally, mobile Android devices cannot cast sound out.
- When you cast your Windows/Mac/Chrome screen to a ViewBoard or display, the selected full screen unit will not be broadcasted back to your device to avoid repetitive screen casting.
- The active presenter can touch each of the participant's screens to remotely control casting devices.
- The number of multi-screen presenters on-screen depends on your Windows CPU processor performance and router specifications.

Casting from Windows, MacBook, and Chrome Devices

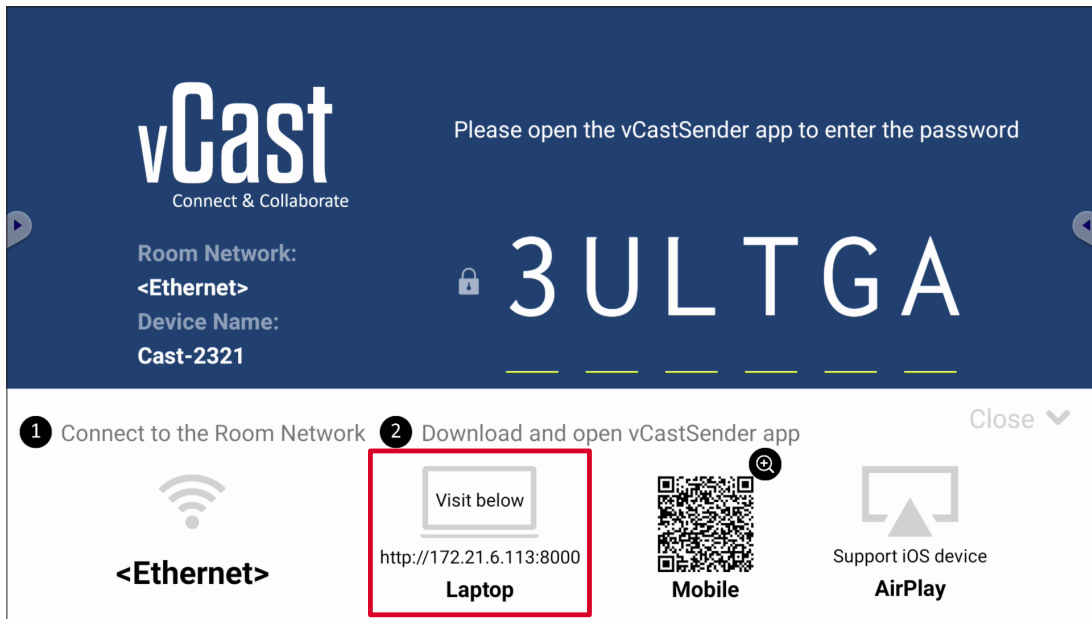

1. Ensure the client device (e.g., laptop) is connected to the same network as the ViewBoard.

NOTE: The network name can be found under **Room Network**.

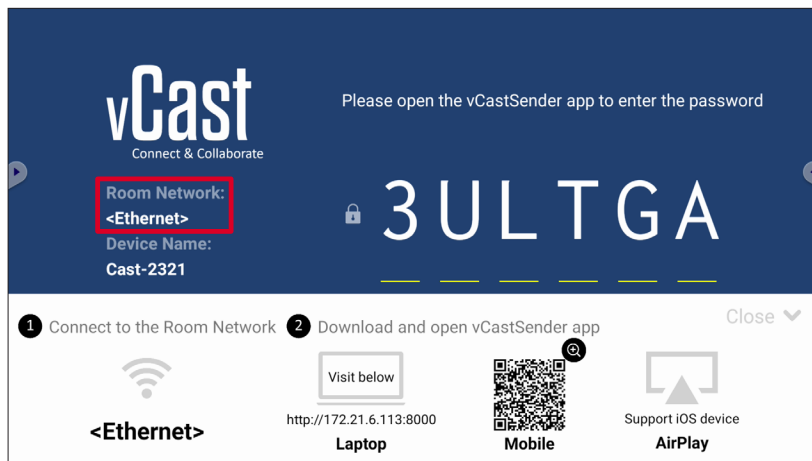

2. On the client device, visit the address that is shown on the ViewBoard to download and install the vCastSender application.

3. After installing, launch the vCastSender application.

4. To connect to the ViewBoard, input the PIN code and click OK.

NOTE: The PIN code can be found as highlighted below:

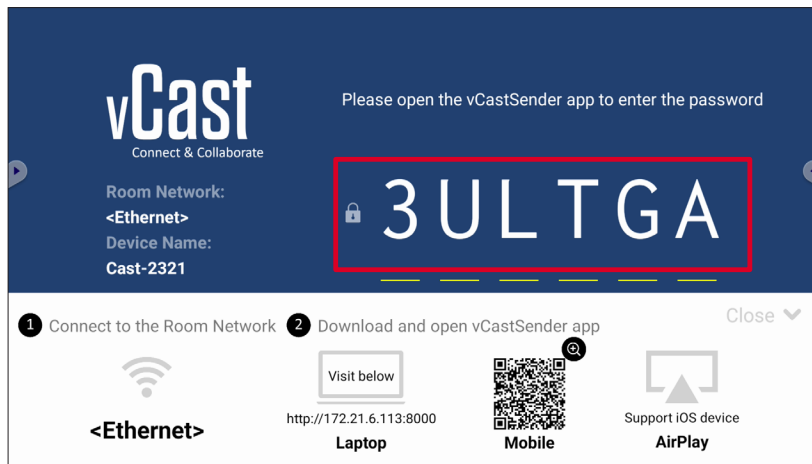

5. Additionally, you can connect to the ViewBoard by clicking **Device List** then the **Device Name** listed.

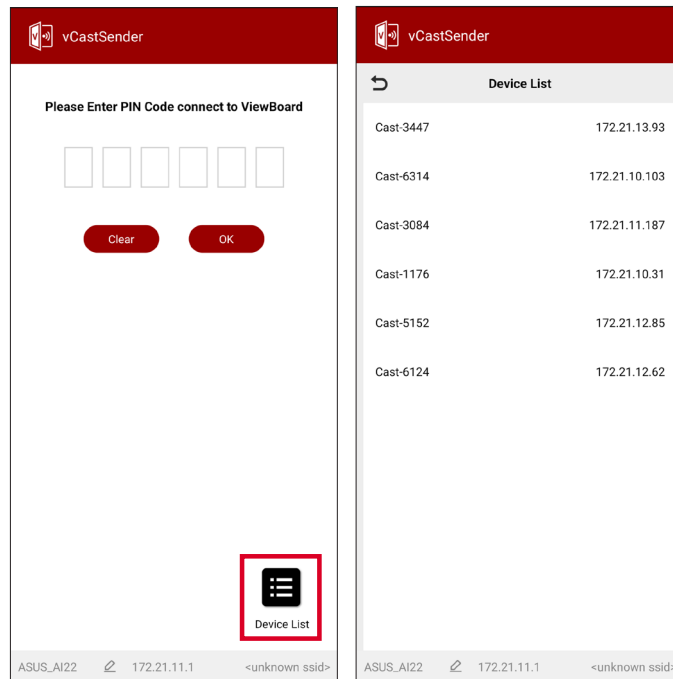

NOTE: The **Device Name** can be found as highlighted below:

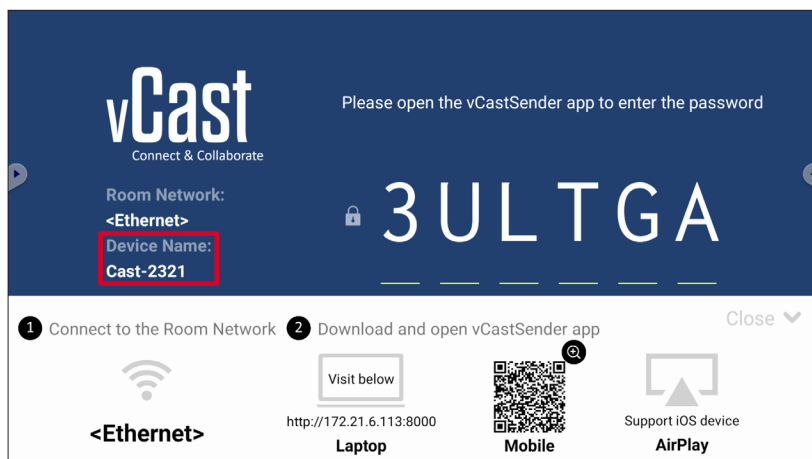

Casting from Android Devices

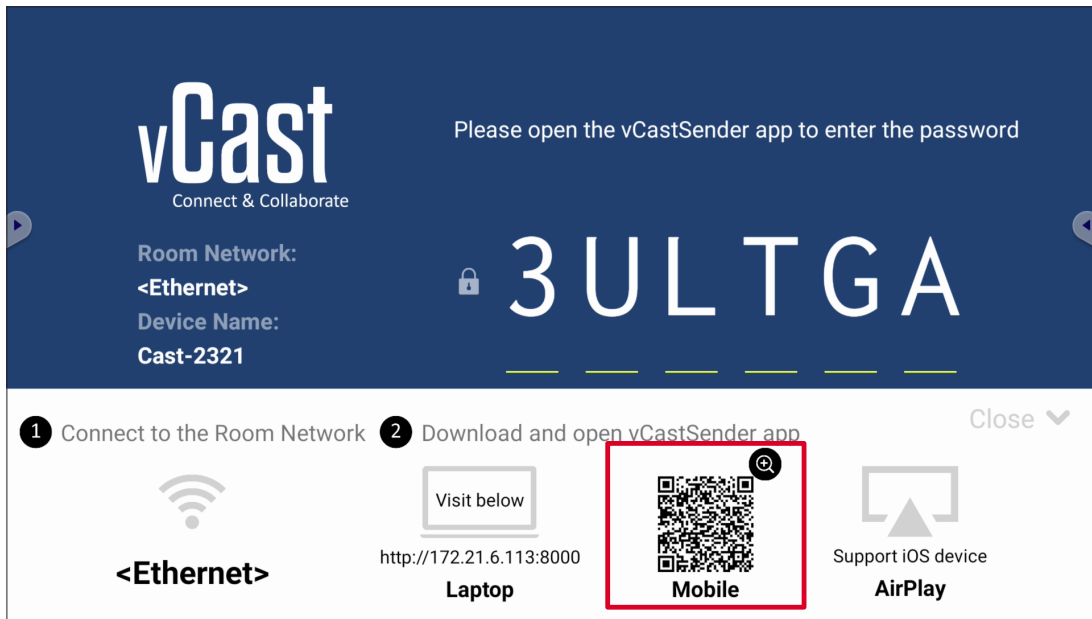

1. Ensure the client device (e.g., Android phone or tablet) is connected to the same network as the ViewBoard.

NOTE: The network name can be found under **Room Network**.

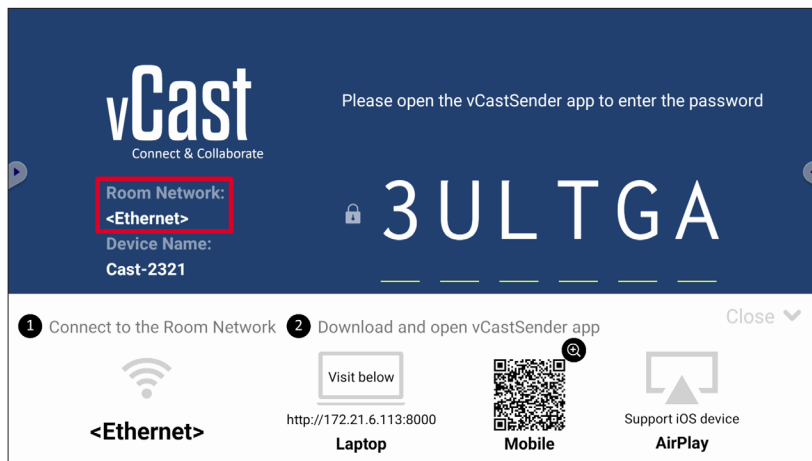

2. On the Android client device, scan the QR code shown on the ViewBoard to directly download the vCastSender application, or download the application from the Google Play Store.

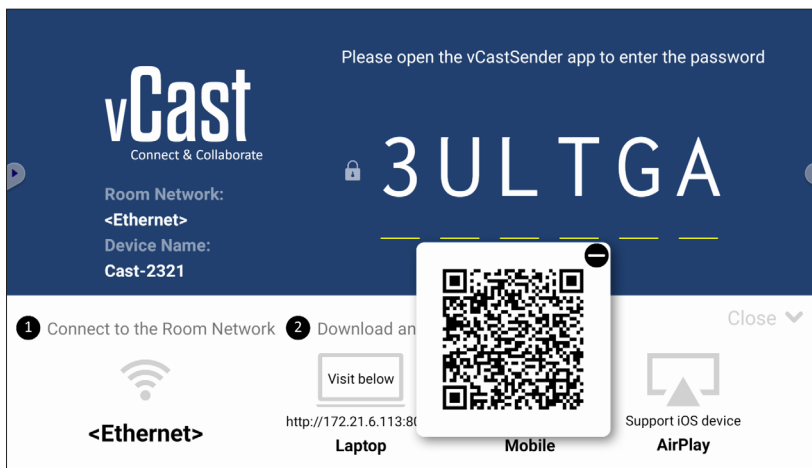

- After installing, launch the vCastSender application.
- To connect to the ViewBoard, input the PIN code and select **OK**.

NOTE: The **PIN code** can be found as highlighted below:

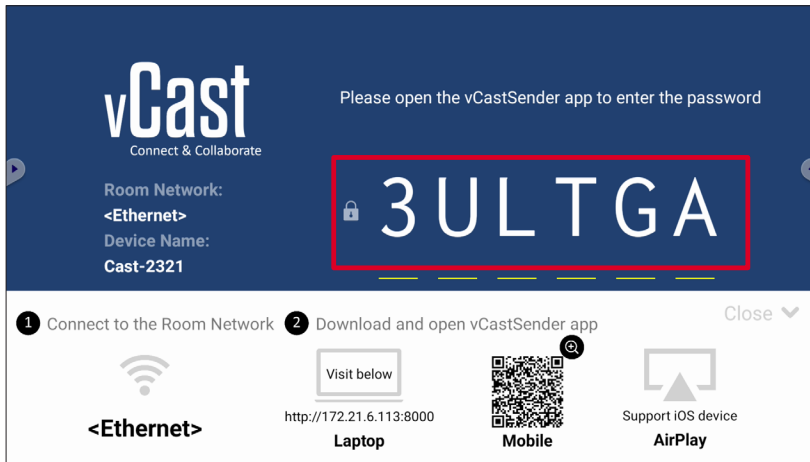

- You can also connect to the ViewBoard by selecting **Device List** then the **Device Name** listed.

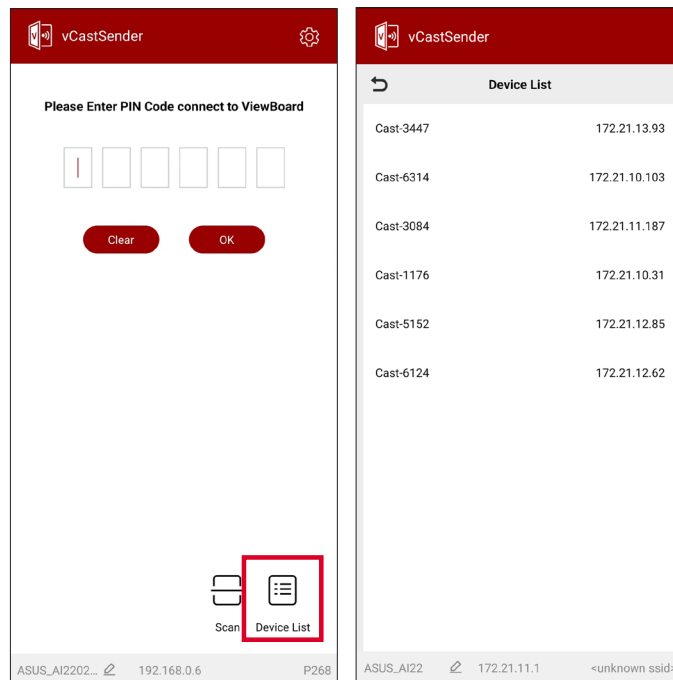

NOTE: The **Device Name** can be found as highlighted below:

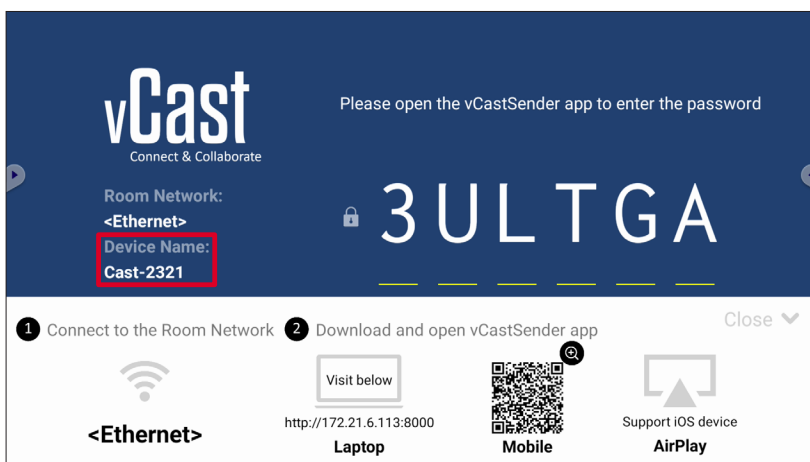

6. Additionally, you can connect to the ViewBoard or by selecting **Scan** then placing the on-screen QR code into the box to automatically connect.

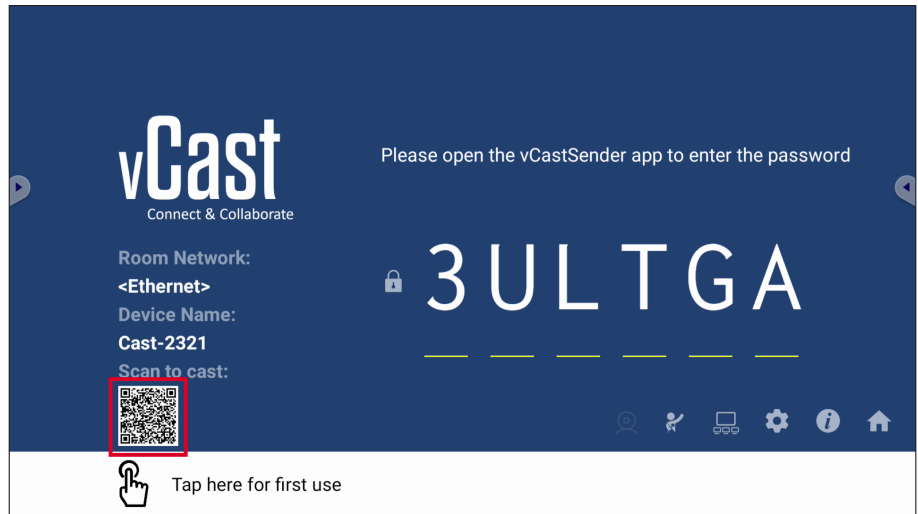
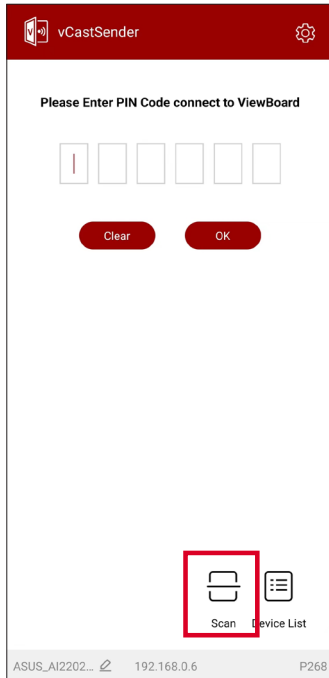

Casting from Apple iOS Devices

Apple AirPlay® is compatible with vCast for screen mirroring and content streaming under the same subnet environment only. An “AirPlay Password” will be generated on-screen for connection when using AirPlay to cast to a ViewBoard.

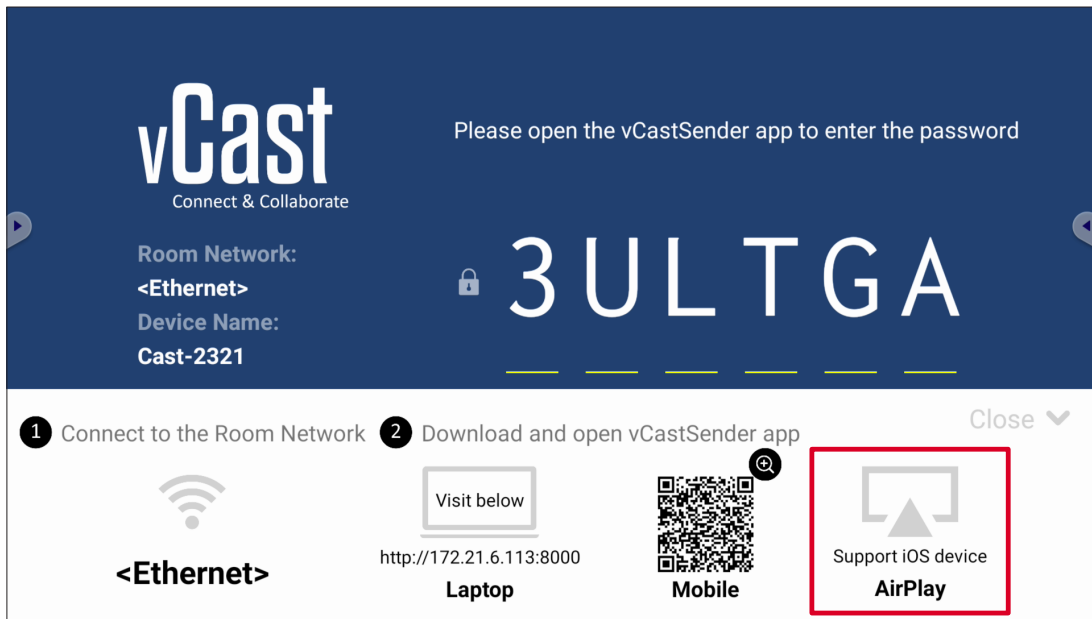

1. Ensure the client device (e.g., iPhone or iPad) is connected to the same network as the ViewBoard.

NOTE: The network name can be found under **Room Network**.

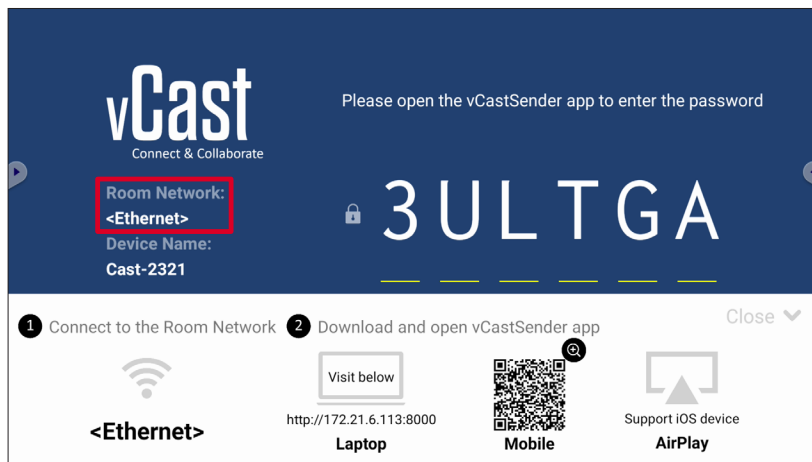

2. On the iOS client device, directly open AirPlay and select the **Device Name** of the ViewBoard to connect.

NOTE: The **Device Name** can be found as highlighted below:

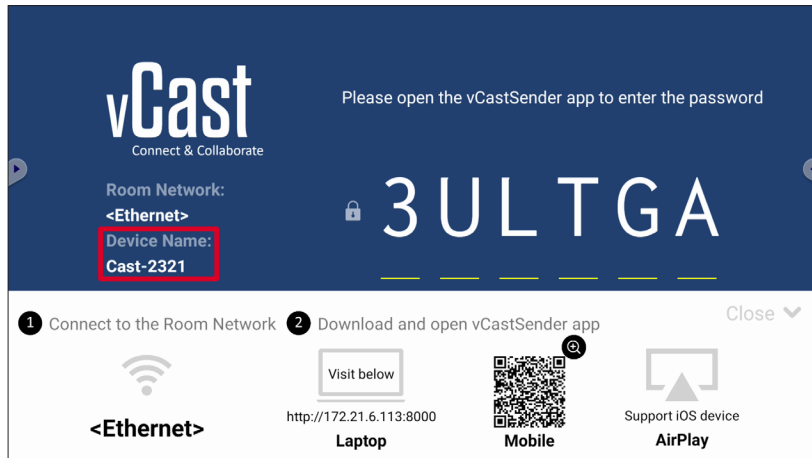

3. Input the generated on-screen **AirPlay Password** on the client device to connect.

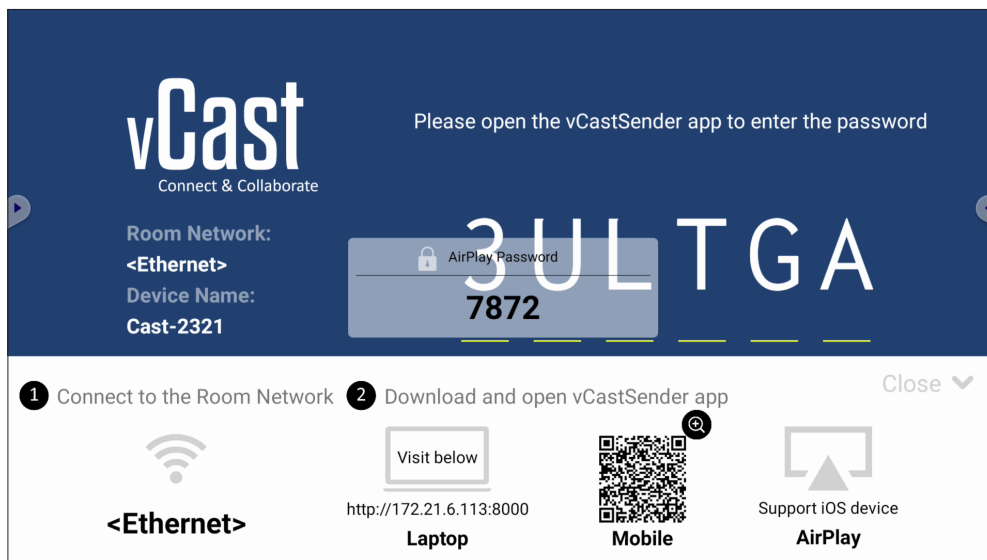

NOTE: In a cross subnet environment, please download and connect with the vCastSender iOS application from the Apple App Store.



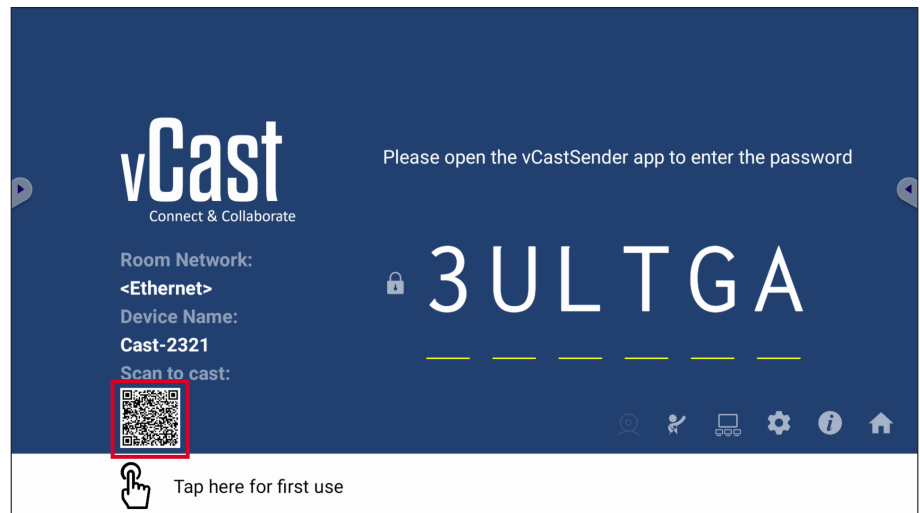
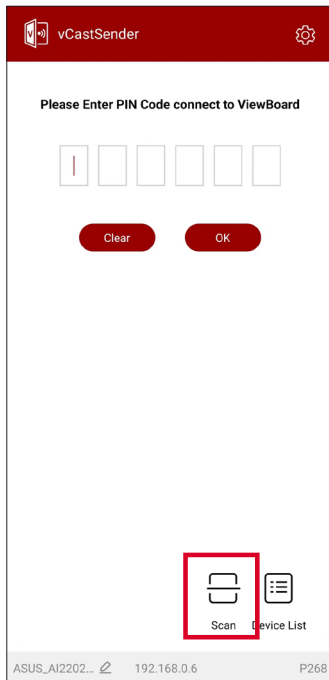



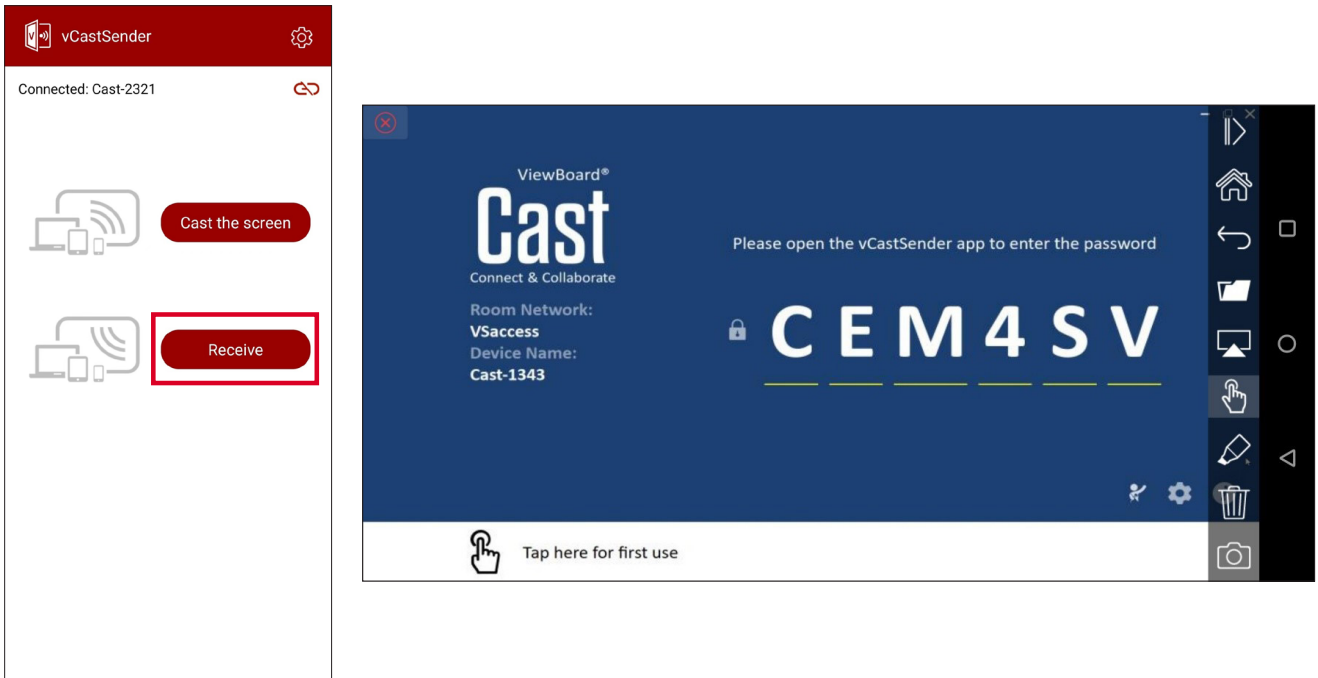

4. You can also connect to the ViewBoard by selecting **Scan** then placing the on-screen QR code into the box to automatically connect.



Connecting to a ViewBoard from a Mobile Device

Once connected, select **Receive**. The ViewBoard will appear on the mobile device with an on-screen toolbar. Users can interact with the ViewBoard with annotations, file sharing, etc.



Item	Description
	Toggle Hide or display the toolbar.
	Home Return to the Home interface.
	Return Return to the previous operation.
	Folder View or open the mobile device's files.
	Share Cast the mobile device's screen to the connected ViewBoard or display.
	Touch Remotely control the connected ViewBoard or display.
	Annotate Make annotations, and adjust the pen color.
	Clear Clear everything on screen.
	Camera Send camera images to the connected ViewBoard or display.

Casting with Chromecast

vCast supports native Chromecast screen sharing via the Chrome browser casting when the Chromecast feature is enabled.

NOTE: Chromecast does not support password protection or multiple-screen casting.

1. Ensure the client device (e.g., laptop) is connected to the same network as the ViewBoard.

NOTE: The network name can be found under **Room Network**.

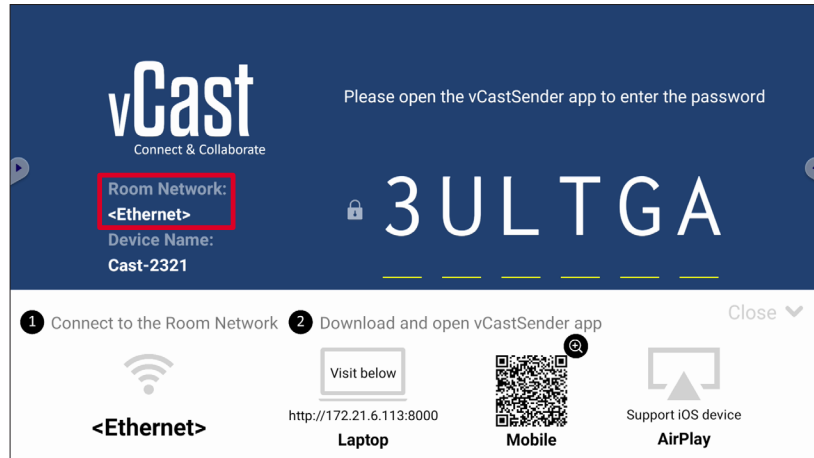

2. Ensure the **Chromecast Enable** checkbox is selected in the vCast settings.

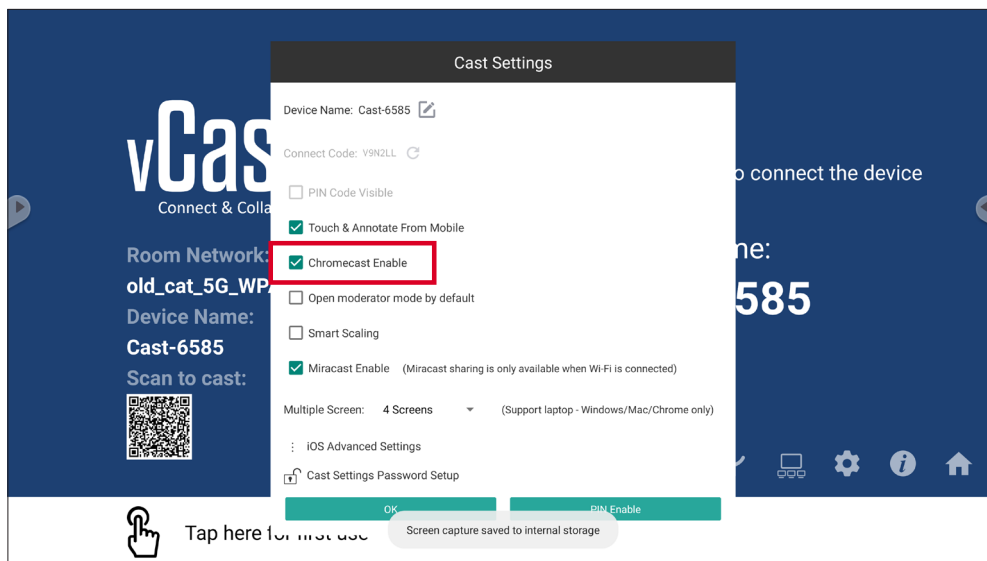

3. In the Chrome browser, go to: **Settings > Save and share > Cast...** > Select the screen to cast to.

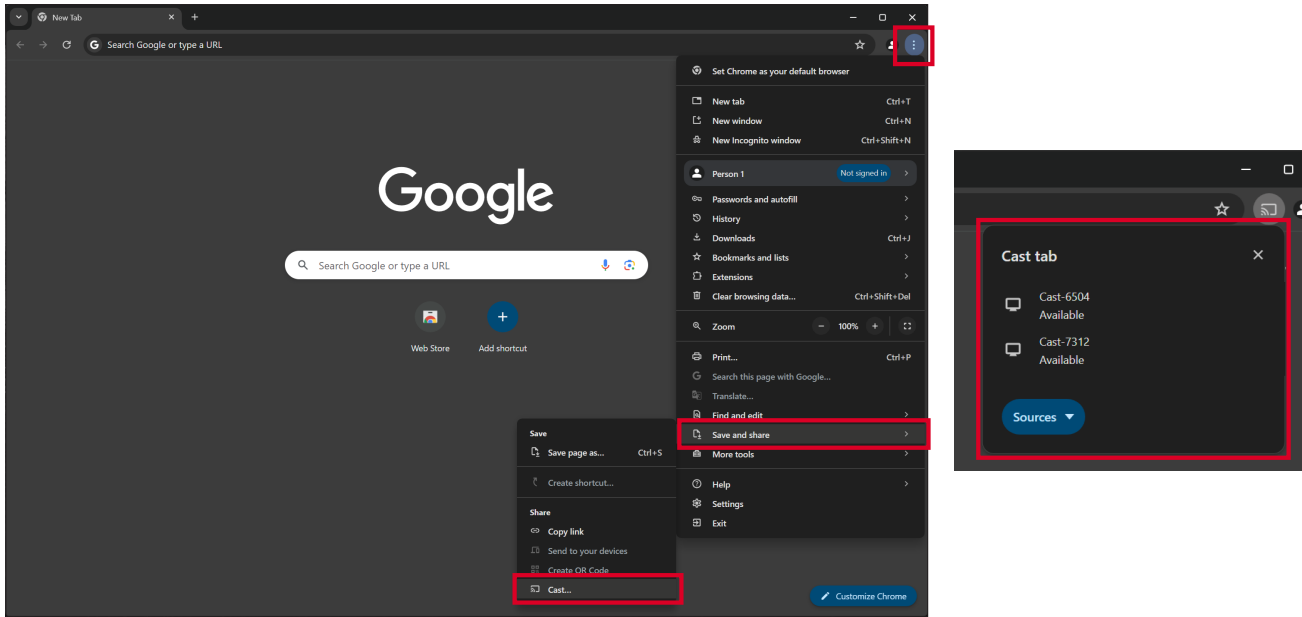

Casting with Miracast

vCast supports native Miracast to cast content from Windows and Android devices to a ViewBoard when the Miracast feature is enabled.

NOTE:

- Miracast does not support password protection or multiple-screen casting.
- Miracast sharing is only available over Wi-Fi.
- Miracast will automatically turn off after being idle for one hour.

1. Ensure the client device (e.g., laptop) is connected to the same network as the ViewBoard.

NOTE: The network name can be found under **Room Network**.

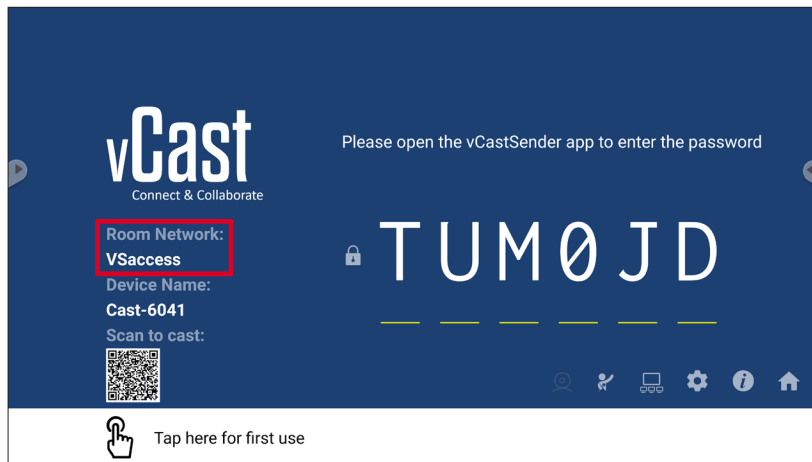

2. Ensure the **Miracast Enable** checkbox is selected in the vCast settings.

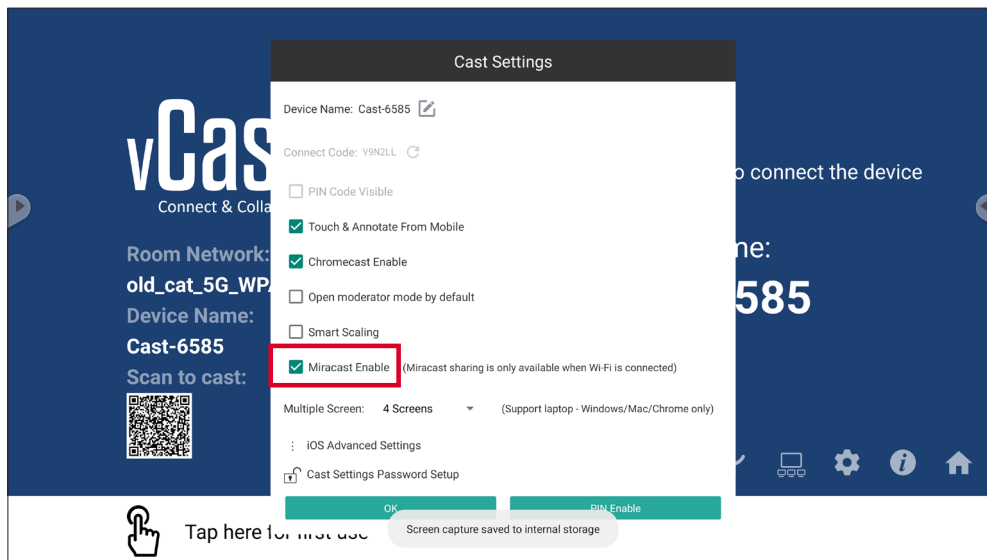

3. Please follow the below steps to cast:

For Windows devices:

1. On the Windows device, press Win + K and select the display to cast to.

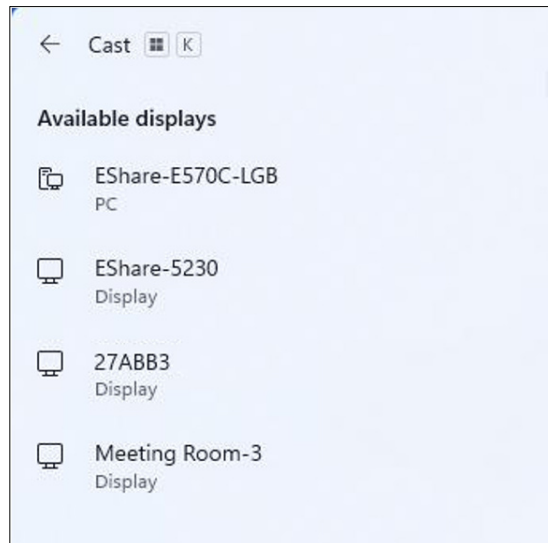

2. Select the checkbox “Allow mouse, keyboard, touch, and pen input from the device” to enable the touch feedback feature.

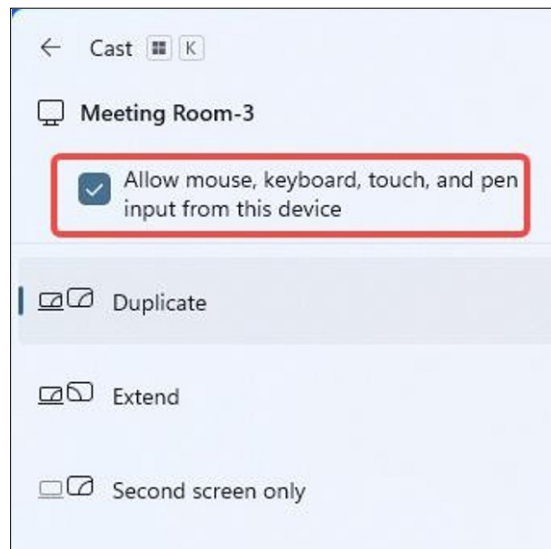

For Android devices:

On the Android device, directly select Cast/Smart View/Wireless Projection then select the display to cast to.

Other Default Applications

Browser

Web browser for surfing the Internet.

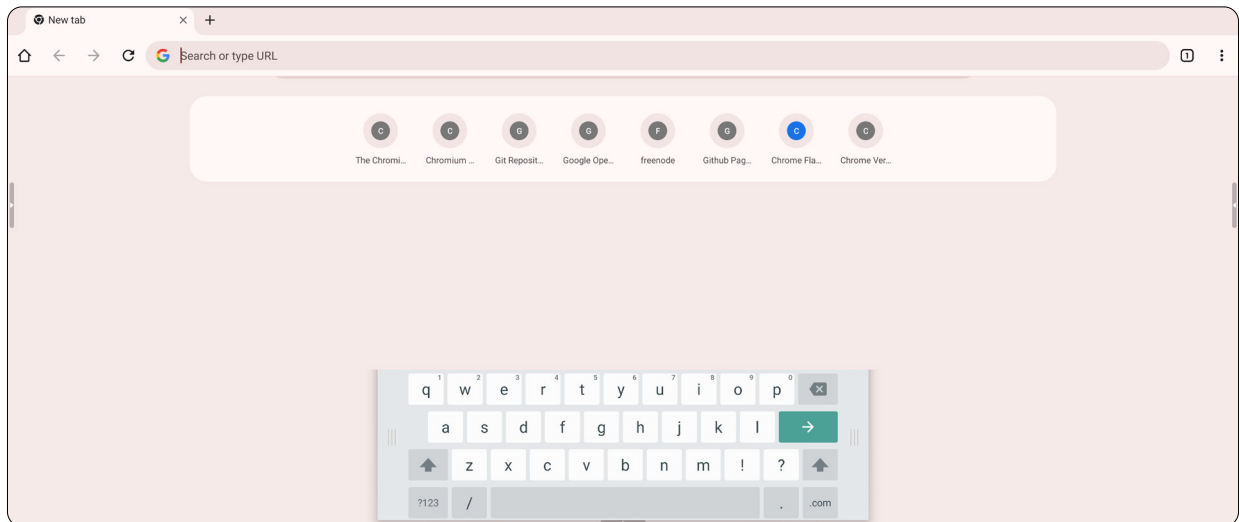

Finder



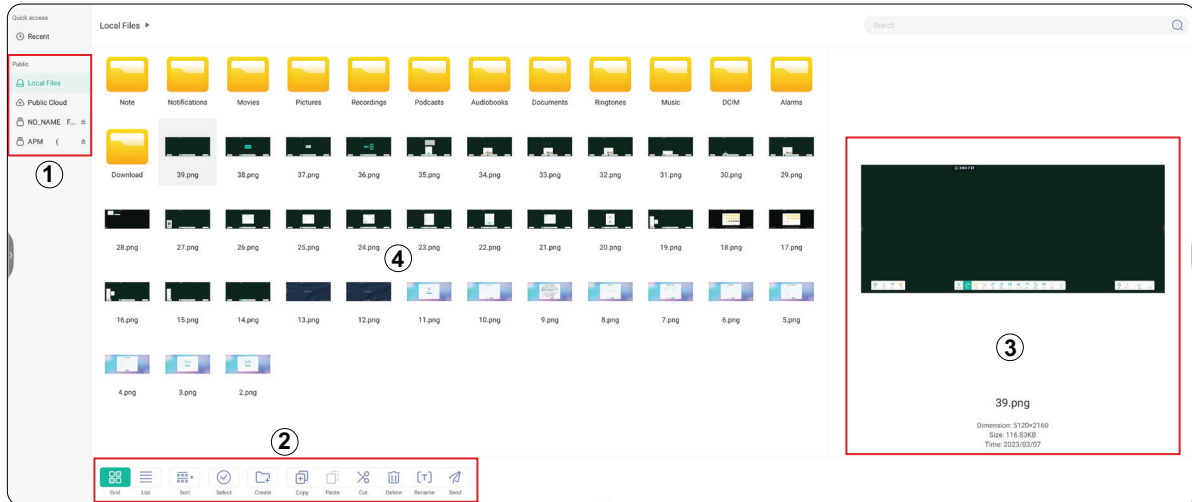







Manage files and folders.



1. Storage Device Display

Select the appropriate storage device.

2. Icons

	Item	Description
	Grid	Display files by grid
	List	Display files by list
	Sort	Sort the files
	Select	Select a file
	Create	Create a new folder
	Copy	Copy a file
	Paste	Paste a copied or cut file
	Cut	Cut a file
	Delete	Delete a file
	Rename	Rename a file
	Send	Share a file

3. File Information

Preview the file, show the file's name, size, resolution, and creation date.

4. Main Display Area

Files are displayed here.

Office

Create, edit, and view documents, spreadsheets, presentations, and PDFs.

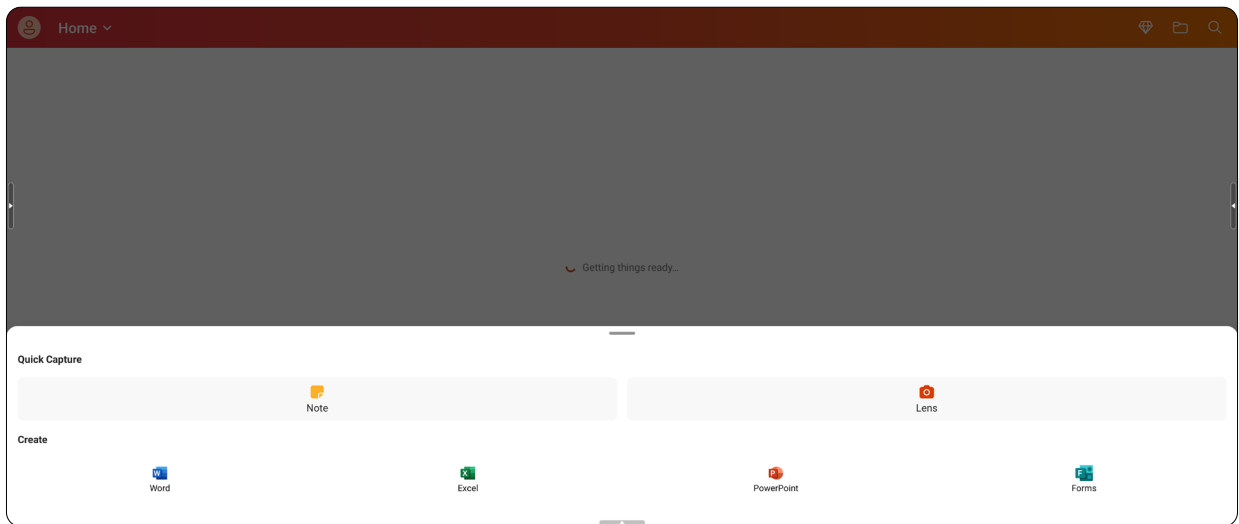
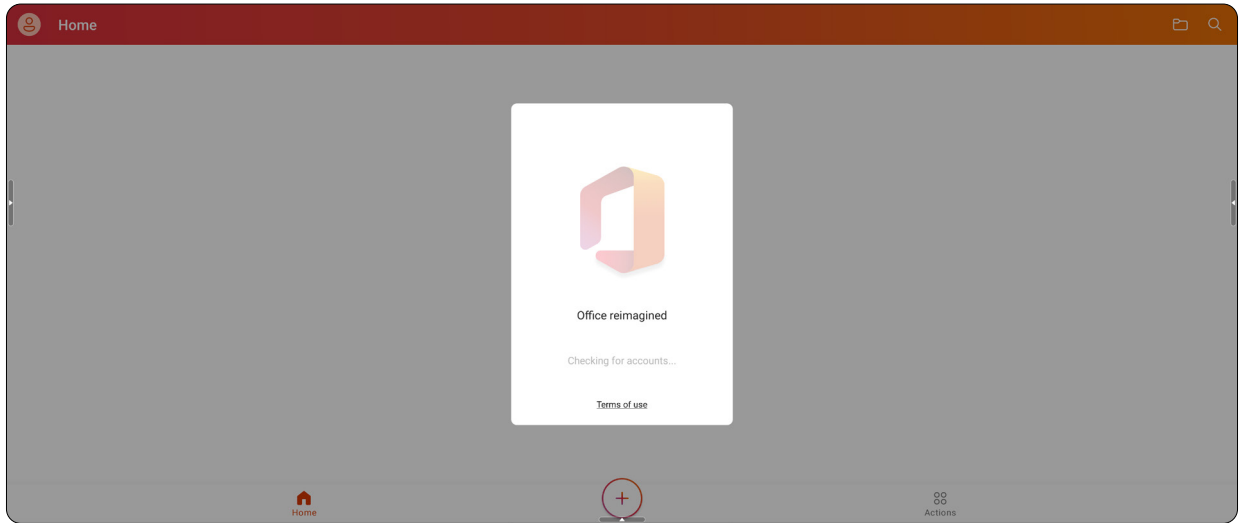

PIP (Picture-in-Picture)

Split the screen into two parts, a main window and an inset window.

NOTE: PIP only works between an Android application (browser, media player, vCast) and an external source.

- To open PIP, select: **All Apps > PIP**.

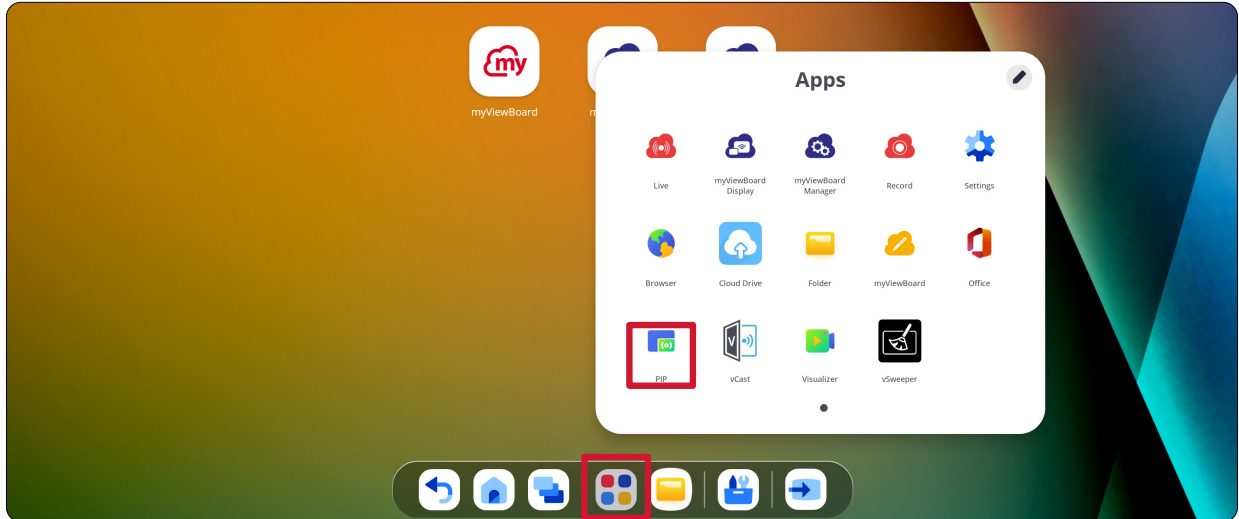

- To adjust the size of the inset window, select **Size**.

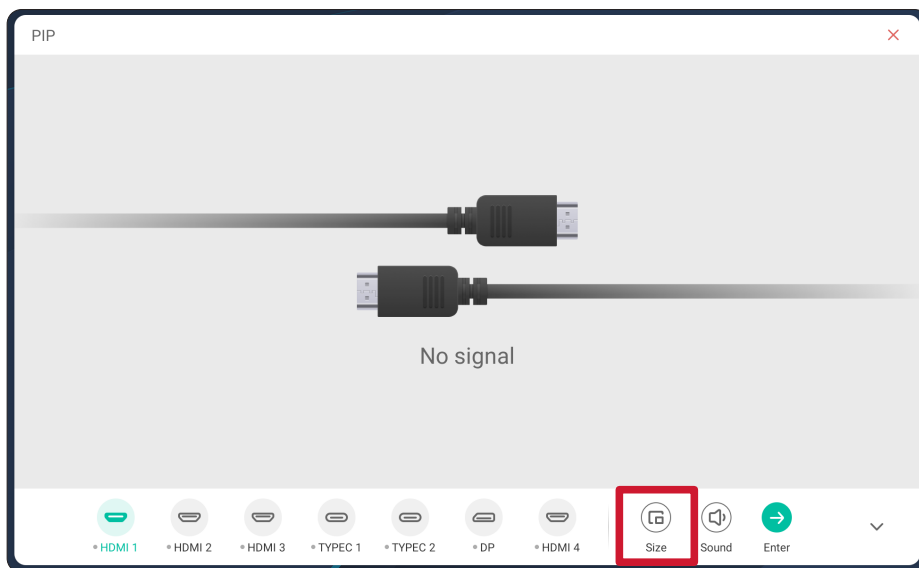

NOTE: The toolbar can be hidden by touching the down arrow.



- To change PIP input source select **HDMI 1, HDMI 2, HDMI 3, HDMI 4, Type C 1, Type C 2, or DP.**

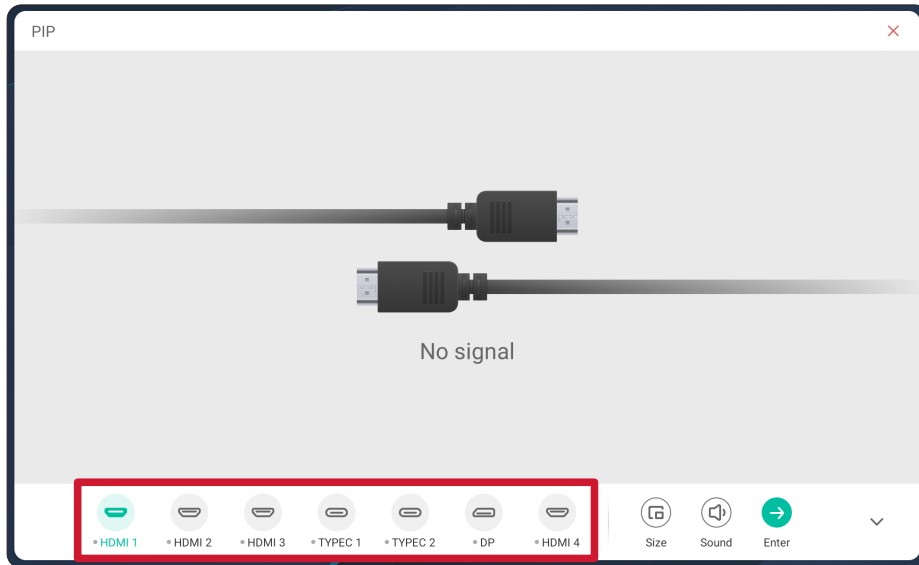

- To control the connected external device's volume, select **Sound.**

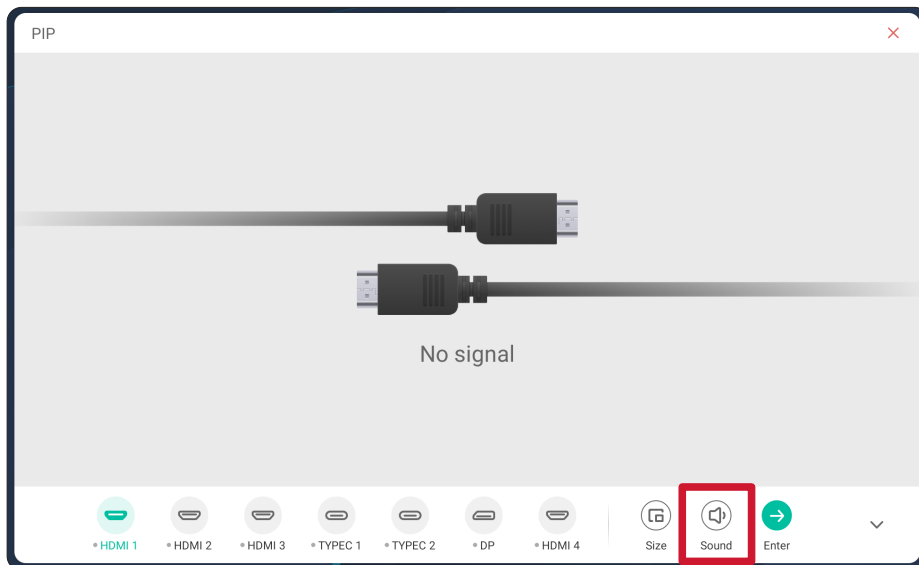

- Select **Enter** to switch to the PIP input source.

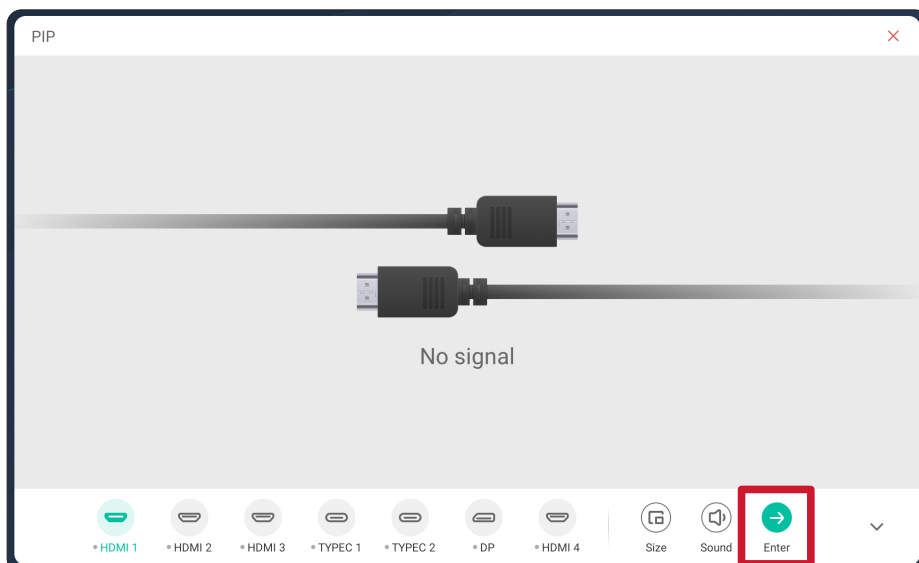

Visualizer

Display video from a connected camera.

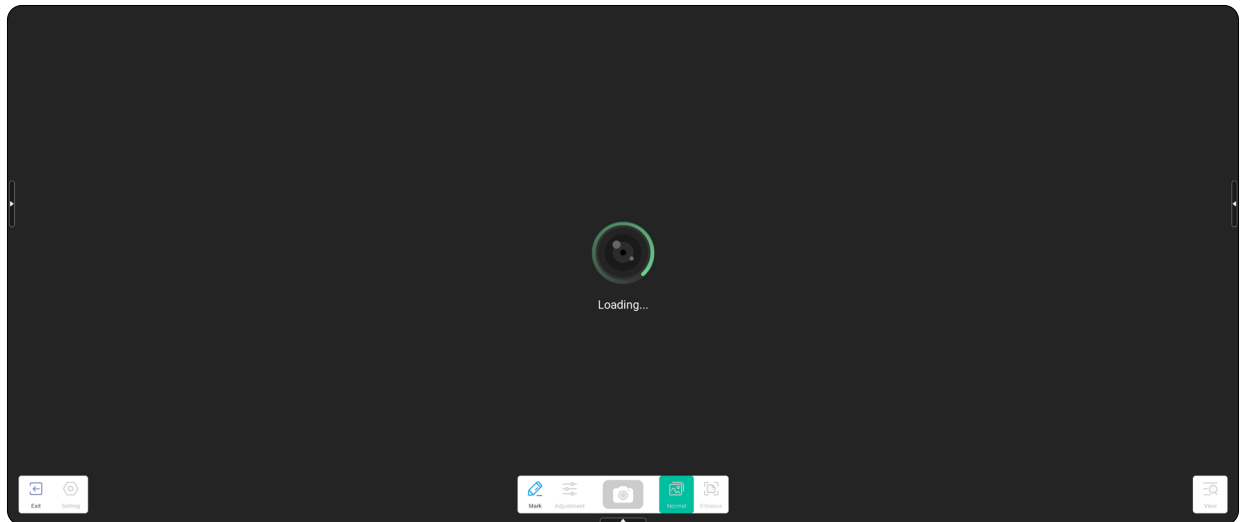

vSweeper

Clear unnecessary data and unwanted files.

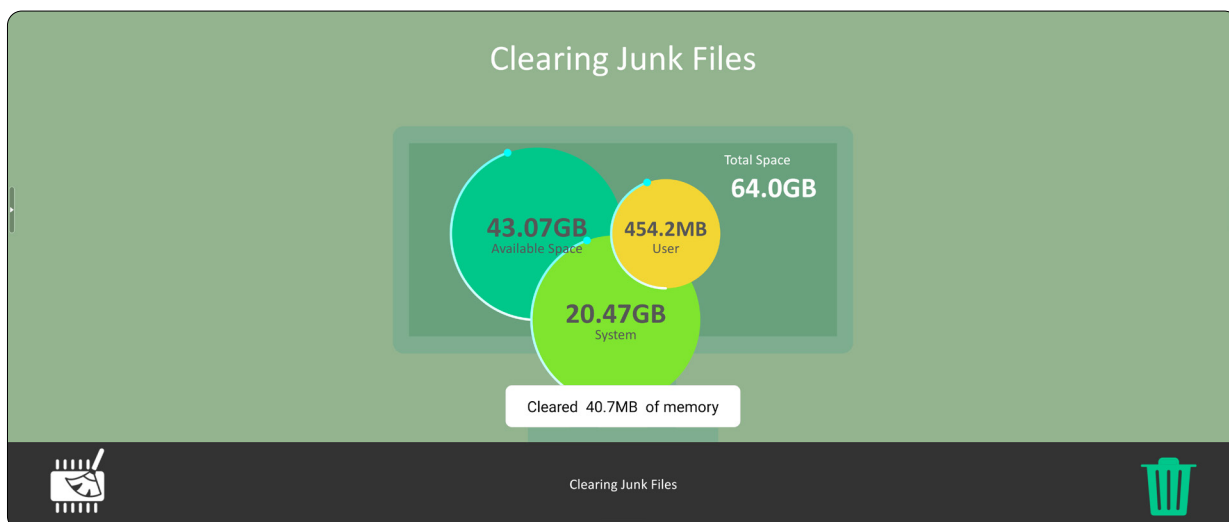
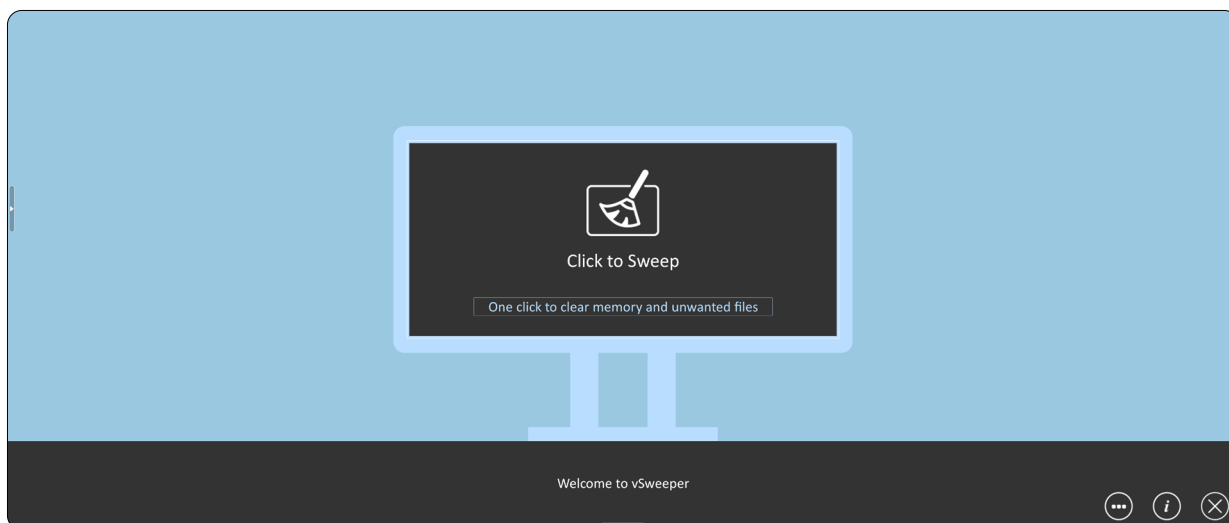

RS-232 Protocol

This document describes the hardware interface spec and software protocols of RS-232 interface communication between ViewSonic LFD and PC or other control units with RS-232 protocol.

The protocol contains three command sections:

- Set-Function
- Get-Function
- Remote control pass-through mode

NOTE: Below, “PC” represents all the control units that can send or receive the RS-232 protocol command.

Description

RS-232 Hardware Specification

ViewSonic LFD communication port on the rear side:

1. Connector type: DSUB 9-Pin Male (or 3.5 mm barrel connector)
2. Use of crossover (null modem) cable for connection
3. Pin Assignment:

Female DSUB 9-Pin

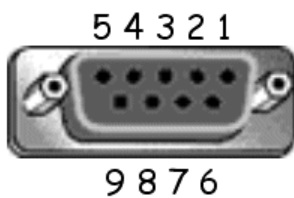

Male DSUB 9-Pin



3.5 mm barrel connector (alternative for limited space)



Pin #	Signal	Remark
1	NC	
2	RXD	Input to Display
3	TXD	Output from Display
4	NC	
5	GND	
6	NC	
7	NC	
8	NC	
9	NC	Provide +5V/2A power for external specific dongle *3.0
frame	GND	

Item	Signal	Remark
Tip	TXD	Output from Display
Ring	RXD	Input to Display
Sleeve	GND	

LAN Hardware Specification

ViewSonic LFD communication port on the rear side:

1. Connector type: 8P8C RJ45
2. Pin Assignment:

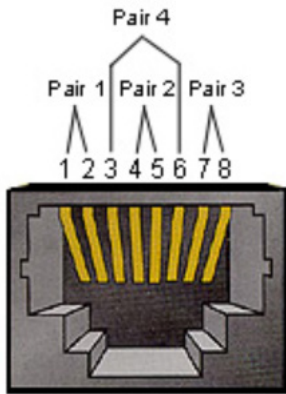

Pin #	Signal	Remark
1	TX+	Output from Display
2	TX-	Output from Display
3	RX+	Input to Display
4	BI_D3+	For 1G case
5	BI_D3-	For 1G case
6	RX-	Input to Display
7	BI_D4+	For 1G case
8	BI_D4-	For 1G case
frame	GND	

RS232 Communication Setting

- Baud Rate Select: 9600bps (fixed)
- Data bits: 8 bits (fixed)
- Parity: None (fixed)
- Stop Bits: 1(fixed)

LAN Communication Setting

- Type: Ethernet
- Protocol: TCP/IP
- Port: 5000 (fixed)
- Cross subnet: No
- Logon Credentials: No

Command Message Reference

PC sends to LFD command packet followed by “CR”. Every time PC sends control command to Display, the Display shall respond as follows:

1. If the message is received correctly it will send “+” (02Bh) followed by “CR” (00Dh)
2. If the message is received incorrectly it will send “-” (02Dh) followed by “CR” (00Dh)

Protocol

Set-Function Listing

The PC can control the Display for specific actions. The Set-Function command allows you to control the Display behavior at a remote site through the RS-232 port. The Set-Function packet format consists of 9 bytes.

Set-Function Description:

- Length:** Total Byte of Message excluding "CR"
- LFD ID** Identification for each of Display (01~98; default is 01)
ID "99" means to apply the set command for all connected displays. Under such circumstances, only ID#1 display has to reply.
The LFD ID can be set via the OSD menu for each Display.
- Command Type** Identify command type,
"s" (0x73h): Set Command
"+" (0x2Bh): Valid command Reply
"- " (0x2Dh): Invalid command Reply
- Command:** Function command code: One byte ASCII code.
- Value[1~3]:** Three bytes ASCII that defines the value.
- CR** 0x0D

Set-Function Format

Send: (Command Type="s")

Name	Length	ID	Command Type	Command	Value1	Value2	Value3	CR
Byte Count	1 Byte	2 Byte	1 Byte	1 Byte	1 Byte	1 Byte	1 Byte	1 Byte
Bytes order	1	2~3	4	5	6	7	8	9

Reply: (Command Type="+" or "-")

Name	Length	ID	Command Type	CR
Byte Count	1 Byte	2 Byte	1 Byte	1 Byte
Bytes order	1	2~3	4	5

NOTE: When PC applies command to all displays (ID=99), only the #1 set needs to reply by the name of ID=1.

Example 1: Set Brightness as 76 for Display (#02) and this command is valid

Send (Hex Format)

Name	Length	ID	Command Type	Command	Value1	Value2	Value3	CR
Hex	0x38	0x30 0x32	0x73	0x24	0x30	0x37	0x36	0x0D

Reply (Hex Format)

Name	Length	ID	Command Type	CR
Hex	0x34	0x30 0x32	0x2B	0x0D

Example 2: Set Brightness as 75 for Display (#02) and this command is NOT valid

Send (Hex Format)

Name	Length	ID	Command Type	Command	Value1	Value2	Value3	CR
Hex	0x38	0x30 0x32	0x73	0x24	0x30	0x37	0x35	0x0D

Reply (Hex Format)

Name	Length	ID	Command Type	CR
Hex	0x34	0x30 0x32	0x2D	0x0D

Set-Function Table

A. Basic Function

Set Function	Length	ID	Command		Value Range	Comments	
			Type (ASCII)	Code (ASCII) Code (Hex)			
Power on/ off (standby)	8		s	!	21	000: STBY 001: ON	1. The Power-on via LAN control may work only under specific mode. To see display UG for details. *3.1.1 2. "WOL by MAC address" may available as alternative.*3.2.1
Input Select	8		s	"	22	000: TV 001: AV 002: S-Video 003: YPbPr 004: HDMI1 014: HDMI2 024: HDMI3 034: HDMI4 005: DVI 006: VGA1 016: VGA2 026: VGA3 007: Slot-in PC (OPS/SDM)/HDBT 008: Internal memory 009: DP 00A: Embedded/Main (Android)	1. No need for USB 2. For the case of two more same sources, the 2nd digital is used to indicate the extension. 3. The HEX of 00A is 30 30 41.
Brightness	8		s	\$	24	000 ~ 100 900: Bright down (-1) 901: Bright up (+1) *3.1.1	
Backlight*3.2.0	8		A	B	42	000 ~ 100	1. For Android platform whose main mode is controlled by backlight and the other sources are controlled by brightness. 2. Derived from Color calibration. *3.2.0
Power lock	8		s	4	34	000: Unlock 001: Lock	*See note in details
Volume	8		s	5	35	000 ~ 100 900: Volume down(-1) 901:Volume up(+1)	
Mute	8		s	6	36	000: OFF 001: ON (mute)	

Button lock	8		s	8	38	000: Unlock 001: Lock	*See note in details
Menu lock	8		s	>	3E	000: Unlock 001: Lock	*See note in details
Number *3.1.1	8		s	@	40	000~009	
Key Pad *3.1.1	8		s	A	41	000: UP 001: DOWN 002: LEFT 003: RIGHT 004: ENTER 005: INPUT 006: MENU/(EXIT) 007: EXIT	
Remote Control	8		s	B	42	000: Disable 001: Enable 002: Pass through	Disable: RCU will be no function Enabled: RCU controls normally Pass through: Display will bypass the RC code to connected device via the RS232 port, but not react itself.
Restore default	8		s	~	7E	000	Recover to factory setting

NOTE:

1. Behavior at Lock Modes

Lock Mode	Behavior
Button Lock	<ol style="list-style-type: none"> 1. Lock all buttons on the front panel and RCU, except for "Power" 2. All the SET functions should be workable via RS-232, even the ones with according hot key in RCU like Mute,...etc.
MENU Lock	<ol style="list-style-type: none"> 1. Lock "MENU" key of front panel and RCU 2. The Factory and Hospitality modes should not be blocked for the model using MENU-combined key to enter these two modes. Alternative approach will be indicated separately if any limitation by model.
POWER Lock	<ol style="list-style-type: none"> 1. Lock "POWER" key on the front and RCU. 2. The SET_POWER on/off should be workable via RS-232, but does not mean the POWER lock will be released under this case. 3. Can not be unlocked by reset in OSD setting 4. Will auto AC power-on in power-lock 5. Under power-lock, the set will not enter power saving when no PC signal and neither not turn off when no other video signals after 15 minutes.
Remote control disable	Lock the RCU keys, but keep the front panel buttons workable.

2. Wake-on-LAN by MAC address as alternative for SET Power on

(Length=126 Bytes)

6 Bytes	6 Bytes (#1)	6 Bytes (#2)	...	6 Bytes (#16)	24 Bytes
0xFF FF ... FF	MAC address	MAC address	...	MAC address	0x00 00 ... 00

B. Optional Function

Set Function	Length	ID	Command		Value Range (Three ASCII bytes)	Comments
			Type (ASCII)	Code (ASCII) Code (Hex)		
Contrast	8		s	# 23	000 ~ 100	
Sharpness	8		s	% 25	000 ~ 100	
Color	8		s	& 26	000 ~ 100	
Tint	8		s	' 27	000 ~ 100	
Backlight On_Off	8		s	(29	000: Off 001: On	
Color mode	8		s) 29	000: Normal 001: Warm 002: Cold 003: Personal	
Surround sound	8		s	- 2D	000: OFF 001: ON	
Bass	8		s	. 2E	000 ~ 100	
Treble	8		s	/ 2F	000 ~ 100	
Balance	8		s	0 30	000 ~ 100	050 is central
Picture Size	8		s	1 31	000: FULL (16:9) 001: NORMAL (4:3) 002: REAL (1:1) *3.1.0	
OSD language	8		s	2 32	000: English 001: French 002: Spanish	Could be extended for more supported languages by model
PIP-Mode	8		s	9 39	000: OFF 001: PIP(POP) 002: PBP	
PIP-Sound select	8		s	: 3A	000: Main 001: Sub	
PIP-Position	8		s	; 3B	000: Up 001: Down 002: Left 003: Right	
PIP-Input	8		s	7 37 *2.9	000: TV 001: AV 002: S-Video 003: YPbPr 004: HDMI1 014: HDMI2 024: HDMI3 034: HDMI4 005: DVI 006: VGA1 016: VGA2 026: VGA3 007: Slot-in PC (OPS/SDM)/HDBT 008: Internal memory 009: DP 00A: Embedded/Main (Android)	Value range is same as SET-Input select

Tiling-Mode	8		s	P	50	000: OFF 001: ON	(for video wall)
Tiling-Compensation	8		s	Q	51	000: OFF 001: ON	(for video wall) Bezel width compensation
Tiling-H by V Monitors	8		s	R	52	01x~09x: H 0x1~0x9: V	(for video wall) 1. 2nd digital for H monitors 2. 3rd digital for V monitors
Tiling-Position	8		s	S	53	001~025	(for Video wall) Copy the screen of Position# to identified display
Date: Year	8		s	V	56	Y17~Y99	Last 2 digits (20)17~(20)99
Date: Month	8		s	V	56	M01~M12	2 digits
Date: Day	8		s	V	56	D01~D31	2 digits
Time: Hour	8		s	W	57	H00~H23	24-hr format. 2 digits.
Time: Min	8		s	W	57	M00~M59	2 digits
Time: Sec	8		s	W	57	S00~S59	2 digits

NOTE:

1. Tiling definition of H Monitors, V Monitors, and Position

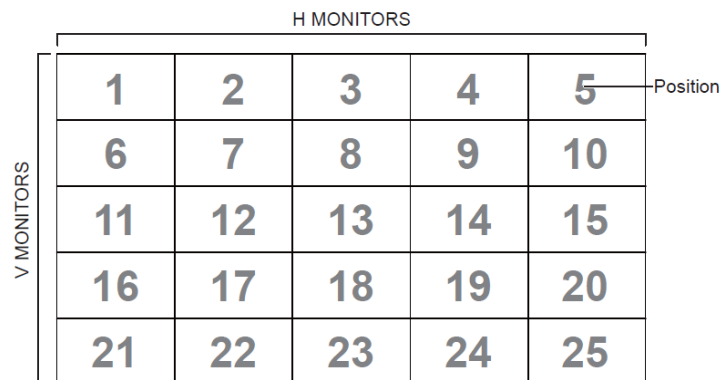

2. Set Date example

Date: 2017-3/15

Send: 0x 38 30 31 73 56 59 31 37 0D ("Y17")

Send: 0x 38 30 31 73 56 4D 30 33 0D ("M03")

Send: 0x 38 30 31 73 56 44 31 35 0D ("D15")

3. Set Time example

Time: 16:27:59

Send: 0x 38 30 31 73 57 48 31 36 0D ("H16")

Send: 0x 38 30 31 73 57 4D 32 37 0D ("M27")

Send: 0x 38 30 31 73 57 53 35 39 0D ("S59")

Get-Function Listing

The PC can interrogate the LFD for specific information. The Get-Function packet format consists of 9 bytes which is similar to the Set-Function packet structure. Note that the “Value” byte is always = 000.

Get-Function Description:

- Length:** Total Byte of Message excluding “CR”.
- TV/DS ID** Identification for each of TV/DS (01~98; default is 01).
- Command Type** Identify command type,
 “g” (0x67h) : Get Command
 “r” (0x72h) : Valid command Reply
 “-” (0x2Dh) : Invalid command Reply
- Command:** Function command code: One byte ASCII code.
- Value[1~3]:** Three bytes ASCII that defines the value.
- CR** 0x0D

Get-Function Format

Send: (Command Type=“g”)

Name	Length	ID	Command Type	Command	Value1	Value2	Value3	CR
Byte Count	1 Byte	2 Byte	1 Byte	1 Byte	1 Byte	1 Byte	1 Byte	1 Byte
Bytes order	1	2~3	4	5	6	7	8	9

Reply: (Command Type=“r” or “-”)

If the Command is valid, Command Type = “r”

Name	Length	ID	Command Type	Command	Value1	Value2	Value3	CR
Byte Count	1 Byte	2 Byte	1 Byte	1 Byte	1 Byte	1 Byte	1 Byte	1 Byte
Bytes order	1	2~3	4	5	6	7	8	9

If the Command is NOT valid, Command Type = “-”

Name	Length	ID	Command Type	CR
Byte Count	1 Byte	2 Byte	1 Byte	1 Byte
Bytes order	1	2~3	4	5

Example 1: Get Brightness from TV-05 and this command is valid. The Brightness value is 67.

Send (Hex Format)

Name	Length	ID	Command Type	Command	Value1	Value2	Value3	CR
Hex	0x38	0x30 0x35	0x67	0x62	0x30	0x30	0x30	0x0D

Reply (Hex Format)

Name	Length	ID	Command Type	Command	Value1	Value2	Value3	CR
Hex	0x38	0x30 0x35	0x72	0x62	0x30	0x36	0x37	0x0D

Example 2: Get Color from Display (#05), but the Color command is not supported by this model.

Send (Hex Format)

Name	Length	ID	Command Type	Command	Value1	Value2	Value3	CR
Hex	0x38	0x30 0x35	0x67	0x26	0x30	0x30	0x30	0x0D

Reply (Hex Format)

Name	Length	ID	Command Type	CR
Hex	0x34	0x30 0x35	0x2D	0x0D

Get-Function Table

A. Basic Function

Get Function	Length	ID	Command		Response Range (Three ASCII bytes)	Comments
			Type (ASCII)	Code (ASCII) Code (Hex)		
Get-Brightness	8		g	b 62	000 ~ 100	
Get-Backlight ^{*3.2.0}	8		a	B 42	000 ~ 100	1. For Android platform whose main mode is controlled by backlight and the other sources are controlled by brightness. 2. Derived from Color calibration. ^{*3.2.0}
Get-Volume	8		g	f 66	000 ~ 100	
Get-Mute	8		g	g 67	000: Off 001: On (muted)	
Get-Input select	8		g	j 6A	000~ 100~	1. 1st digit for signal detection: 0 means "no signal"; 1 means "signal detected" 2. 2nd & 3rd digit: See Set-function table
Get-Power status: ON/ STBY	8		g	l 6C	001: ON 000: STBY	
Get-Remote control	S		g	n 6E	000: Disable 001: Enable 002: Pass through	Get RCU mode status
Get-Power lock	8		g	o 6F	000: Unlock 001: Lock	
Get-Button lock	8		g	p 70	000: Unlock 001: Lock	
Get-Menu lock	8		g	l 6C	000: Unlock 001: Lock	
Get-ACK	8		g	z 7A	000	This command is used to test the communication link
Get-Thermal	8		g	0 30	000~100: 0~+100 deg C -01~-99: -1~-99 deg C	
Get-Operation time ^{*3.2.0}	8		g	1 31	000	1. Accumulated hours in 6-digit integer (000,001~999,999) ^{*3.2.0} 2. Can not be reset when FW update and Factory initiation ^{*3.2.2} 3. Reply in new 32-byte format ^{*3.2.0}
Get-Device name	8		g	4 34	000	Reply in new 32-byte format ^{*3.2.0}

Get-MAC address	8		g	5	35	000	(for the model with LAN) Reply in new 32-byte format*3.2.0
Get-IP address *3.2.0	8		g	6	36	000	(for the model with LAN) Reply in new 32-byte format*3.2.0
Get-Serial number *3.2.0	8		g	7	37	000	Reply in new 32-byte format *3.2.0
Get-FW version *3.2.0	8		g	8	38	000	Reply in new 32-byte format *3.2.0

NOTE:

1. Get Operation Hour example

Assumed the accumulated operation hour is 123,456 hrs

Send: 0x 38 30 31 67 31 30 30 30 0D (Get Operation hour)

Reply: 0x 32 30 31 72 31 31 32 33 34 35 36 00 00 ... 00 00 0D

2. Get Device Name example

Assumed the device name is CDE-5500

Send: 0x 38 30 31 67 34 30 30 30 0D (Get Device Name)

Reply: 0x 32 30 31 72 34 43 44 45 2D 35 35 30 30 00 00 ... 00 00 0D

Assumed the device name is "NMP-302#1"

Send: 0x 38 30 31 67 34 30 30 30 0D (Get Device Name)

Reply: 0x 32 30 31 72 34 4E 4D 50 2D 33 30 32 23 31 00 00 ...00 00 0D

3. Get MAC address example

Assumed the MAC address is 00:11:22:aa:bb:cc

Send: 0x 38 30 31 67 35 30 30 30 0D (Get MAC add)

Reply: 0x 32 30 31 72 35 30 30 31 31 32 32 61 61 62 62 63 63 00 00...00 00 0D

4. Get IP address example

Assumed the IP address is 192.168.100.2

Send: 0x 38 30 31 67 36 30 30 30 0D (Get IP address)

Reply: 0x 32 30 31 72 36 31 39 32 2E 31 36 38 2E 31 30 30 2E 32 00 00...00 00 0D

5. Get Serial number example

Assumed the Serial number is ABC180212345

Send: 0x 38 30 31 67 37 30 30 30 0D (Get Serial number)

Reply: 0x 32 30 31 72 37 41 42 43 31 38 30 32 31 32 33 34 35 00 00...00 00 0D

6. Get FW version example

Assumed the FW version is 3.02.001

Send: 0x 38 30 31 67 38 30 30 30 0D (Get FW version)

Reply: 0x 32 30 31 72 38 33 2E 30 32 2E 30 30 31 00 00...00 00 0D

B. Optional Function

Get Function	Length	ID	Command		Response Range	Comments
			Type (ASCII)	Code (ASCII) / Code (Hex)		
Get-Contrast	8		g	a / 61	000 ~ 100	
Get-Sharpness	8		g	c / 63	000 ~ 100	
Get-Color	8		g	d / 64	000 ~ 100	
Get-Tint	8		g	e / 65	000 ~ 100	
Get-Backlight On_Off	8		g	h / 68	000: Off 001: On	
Get-PIP mode	8		g	t / 74	000: OFF 001: PIP (POP) 002: PBP	
Get-PIP input	8		g	u / 75	000 ~	See Set-input select
Get-Tiling Mode	8		g	v / 76	000: OFF 001: ON	(for Video wall)
Get-Tiling Compensation	8		g	w / 77	000: OFF 001: ON	(for Video wall) Bezel width compensation
Get-Tiling H by V monitors	8		g	x / 78	01x~09x: H monitors 0x1~0x9: V monitors	(for Video wall) 1. 2nd digital for H monitors 2. 3rd digital for V monitors
Get-Tiling position	8		g	y / 79	000: OFF 001~025	(for Video wall) Copy the screen of Position# to identified display
Get-Date: Year	8		g	2 / 32	Y00~Y00	Last 2 digits (20)17~(20)99
Get-Date: Month	8		g	2 / 32	M00~M00	2 digits
Get-Date: Day	8		g	2 / 32	D00~M00	2 digits
Get-Time: Hour	8		g	3 / 33	H00~H00	24-hr format. 2 digits
Get-Time: Min	8		g	3 / 33	M00~M00	2 digits
Get-Time: Sec	8		g	3 / 33	S00~S00	2 digits

NOTE:

1. Get Date example

Assumed the current date of display#01 as below:

Date: 2017-3/15

Send: 0x 38 30 31 67 32 59 30 30 0D (Get Date:Year)

Reply: 0x 38 30 31 72 32 59 31 37 0D ("Y17")

Send: 0x 38 30 31 67 32 4D 30 30 0D (Get Date:Month)

Reply: 0x 38 30 31 72 32 4D 30 33 0D ("M03")

Send: 0x 38 30 31 67 32 44 30 30 0D (Get Date:Day)

Reply: 0x 38 30 31 72 32 44 31 35 0D ("D15")

2. Get Time example

Assumed the current time of display#01 as below:

Time: 16:27:59

Send: 0x 38 30 31 67 33 48 30 30 0D (Get Time:Hour)

Reply: 0x 38 30 31 72 33 48 31 36 0D ("H16")

Send: 0x 38 30 31 67 33 4D 30 30 0D (Get Time:Min)

Reply: 0x 38 30 31 72 33 4D 32 37 0D ("M27")

Send: 0x 38 30 31 67 33 53 30 30 0D (Get Time:Sec)

Reply: 0x 38 30 31 72 33 53 35 39 0D ("S59")

3. Get RS232 Version example

Assumed the version is 3.0.1

Send: 0x 38 30 31 67 36 30 30 30 0D (Get RS232 version)

Reply: 0x 38 30 31 72 36 33 30 31 0D ("301")

C. Auto Reply *3.2.1

The display will send out the updated data/status automatically without getting a query from the host whenever the following data/status is changed by the user through any of the available ways like: remote control unit, front keys, or touch screen.

- Power On/Off
- Input Select
- Brightness
- Backlight
- Volume
- Mute On/Off

Remote Control Pass-through Mode

When the PC sets the Display to Remote Control Pass through mode, the Display shall send a 7-byte packet (followed by “CR”) in response to remote control unit (RCU) button activation. In this mode the remote control shall have no effect on the Display function. For example: “Volume+” will not change the volume of the Display, but instead only sends the “Volume+” code to the PC over the RS-232 port.

IR Pass Through-Function format

Reply: (Command Type=“p”)

Name	Length	ID	Command Type	RCU Code1 (MSB)	RCU Code2 (LSB)	CR
Byte Count	1 Byte	2 Byte	1 Byte	1 Byte	1 Byte	1 Byte
Bytes order	1	2~3	4	5	6	7

Example 1: Remote Control Pass-through when “VOL+” key is pressed for Display (#5)

Send (Hex Format)

Name	Length	ID	Command Type	RCU Code1 (MSB)	RCU Code2 (LSB)	CR
Hex	0x36	0x30 0x35	0x70	0x31	0x30	0x0D

Key	Code (HEX)	Basic *3.1.1	Optional *3.1.1
1	01	V	
2	02	V	
3	03	V	
4	04	V	
5	05	V	
6	06	V	
7	07	V	
8	08	V	
9	09	V	
0	0A	V	
-	0B		V
RECALL (LAST)	0C		V
INFO (DISPLAY)	0D		V
	0E		
ASPECT (ZOOM, SIZE)	0F		V
VOLUME UP (+)	10	V	

VOLUME DOWN (-)	11	V	
MUTE	12	V	
CHANNEL/PAGE UP (+)/ BRIGHTNESS+	13		V
CHANNEL/PAGE DOWN (-)/ BRIGHTNESS-	14		V
POWER	15	V	
SOURCES (INPUTS)	16	V	
	17		
	18		
SLEEP	19		V
MENU	1A	V	
UP	1B	V	
DOWN	1C	V	
LEFT (-)	1D	V	
RIGHT (+)	1E	V	
OK (ENTER, SET)	1F	V	
EXIT	20	V	
	21		
	22		
	23		
	24		
	25		
	26		
	27		
	28		
	29		
	2A		
	2B		
RED ■ (F1)	2C		
GREEN ■ (F2)	2D		
YELLOW ■ (F3)	2E		
BLUE ■ (F4)	2F		

NOTE:

1. This IR-pass-through code is different from the RCU key code.
2. Special control sequence for POWER key under IR-pass through mode.
- 2-1. When Display is OFF and receives the IR POWER code: Display will turn itself on, then forward the POWER code to the host via RS-232.

- 2-2. When Display is ON and receives the IR POWER code: Display will forward the POWER code to the host via RS-232, then turn off itself.
- 2-3. When SET-POWER LOCK is enabled, the Display will not respond to POWER key pressing.
3. The VOLUME UP and VOLUME DOWN code will repeatedly output when you press and hold the keys.

Appendix

Display Modes

HDMI 1 & DisplayPort Mode

Resolution	Refresh Rate (@)
640 x 480	30 Hz, 60 Hz
720 x 480	30 Hz, 60 Hz
720 x 576	30 Hz, 50 Hz, 60 Hz
800 x 600	30 Hz, 60 Hz
1024 x 768	30 Hz, 60 Hz
1152 x 864	30 Hz, 60 Hz
1280 x 600	30 Hz, 60 Hz
1280 x 720	30 Hz, 50 Hz, 60 Hz
1280 x 768	30 Hz, 60 Hz
1280 x 800	30 Hz, 60 Hz
1280 x 960	30 Hz, 60 Hz
1280 x 1024	30 Hz, 60 Hz
1360 x 768	30 Hz, 60 Hz
1366 x 768	30 Hz, 60 Hz
1400 x 1050	30 Hz, 60 Hz
1440 x 900	30 Hz, 60 Hz
1600 x 900	30 Hz, 60 Hz
1600 x 1200	30 Hz, 60 Hz
1680 x 1050	30 Hz, 60 Hz
1792 x 1344	30 Hz, 60 Hz
1856 x 1392	30 Hz, 60 Hz
1920 x 1080	24 Hz, 30 Hz, 50 Hz, 60 Hz
1920 x 1200	30 Hz, 60 Hz
1920 x 1440	30 Hz, 60 Hz
2048 x 1152	30 Hz, 60 Hz
2048 x 1536	30 Hz, 60 Hz
2560 x 1080	30 Hz, 50 Hz, 60 Hz
2560 x 1440	30 Hz, 60 Hz
2560 x 1600	30 Hz, 60 Hz
3440 x 1440	30 Hz, 60 Hz
3840 x 2160	24 Hz, 30 Hz, 50 Hz, 60 Hz
5120 x 2160	30 Hz, 60 Hz

HDMI 2/3/4 & Type C Mode

Resolution	Refresh Rate (@)
640 x 480	60 Hz
720 x 480	60 Hz
720 x 576	60 Hz
800 x 600	60 Hz
1024 x 768	60 Hz
1152 x 864	60 Hz
1280 x 600	60 Hz
1280 x 720	50 Hz, 60 Hz
1280 x 768	60 Hz
1280 x 800	60 Hz
1280 x 960	60 Hz
1280 x 1024	60 Hz
1360 x 768	60 Hz
1366 x 768	60 Hz
1400 x 1050	60 Hz
1440 x 900	60 Hz 60 Hz
1600 x 900	60 Hz
1600 x 1200	60 Hz
1680 x 1050	60 Hz
1792 x 1344	60 Hz
1856 x 1392	60 Hz
1920 x 1080	24 Hz, 30 Hz, 50 Hz, 60 Hz
1920 x 1200	60 Hz
1920 x 1440	60 Hz
2048 x 1152	60 Hz
2560 x 1080	30 Hz, 50 Hz, 60 Hz
2560 x 1440	60 Hz
3440 x 1440	60 Hz
3840 x 2160	24 Hz, 30 Hz, 60 Hz

Troubleshooting

This section describes some common problems that you may experience when using the ViewBoard.

Problem or Issue	Possible Solutions
Remote Control is not working	<ol style="list-style-type: none">1. Check whether something is obstructing the display's remote control receiver.2. Check whether the batteries in the remote control are installed correctly.3. Check whether the batteries need to be replaced.
The unit turns off unexpectedly	<ol style="list-style-type: none">1. Check whether Sleep mode is enabled.2. Check if there is a power outage in your area.3. Turn on the display and see if the problem is with the signal and control system.

PC Mode

Problem or Issue	Possible Solutions
No PC signal	<ol style="list-style-type: none">1. Check the display settings.2. Check the display resolution.3. Adjust the Hs & Vs (synchronization) settings using the OSD menu.4. Check the OPS resolution. Please make sure the OPS 5K Detect setting is set to the correct resolution.
Background streaking	<ol style="list-style-type: none">1. Choose auto adjust.2. Adjust clock and phase.
Unsupported format	<ol style="list-style-type: none">1. Choose auto adjust.2. Adjust clock and phase settings.

Touch Function

Problem or Issue	Possible Solutions
Touch function does not work	<ol style="list-style-type: none">1. Check that drivers are installed correctly.2. Reinstall driver(s).3. Check setup and align it.4. Check whether the touch pen is working properly.

Video Not Working Properly

Problem or Issue	Possible Solutions
No picture/ No sound	<ol style="list-style-type: none">1. Check the Power status.2. Check the signal cable.3. Check that the internal PC is installed correctly.
Picture is unclear or cuts in and out	<ol style="list-style-type: none">1. Check the signal cable.2. Check if other electronics are interrupting the signal.
Poor picture	<ol style="list-style-type: none">1. Adjust chroma, brightness, and contrast settings in the menu.2. Check the signal cable.

Audio Not Working Properly

Problem or Issue	Possible Solutions
No sound	<ol style="list-style-type: none">1. Press the Mute/Unmute button.2. Adjust the volume.3. Check the audio cable.
One speaker only	<ol style="list-style-type: none">1. Adjust the sound balance in the menu.2. Check the sound control panel settings of the computer.3. Check the audio cable.

Maintenance

General Precautions

- Make sure the device is turned off and the power cable is unplugged from the power outlet.
- Never spray or pour any liquid directly onto the screen or case.
- Handle the device with care, as a darker-colored device, if scuffed, may show marks more clearly than a lighter-colored device.
- Do not use the system continuously for long periods of time.

Cleaning the Screen

- Wipe the screen with a clean, soft, lint-free cloth. This removes dust and other particles.
- If the screen is still not clean, apply a small amount of non-ammonia, non-alcohol based glass cleaner onto a clean, soft, lint-free cloth; then wipe the screen.

Cleaning the Case

- Use a soft, dry cloth.
- If the case is still not clean, apply a small amount of non-ammonia, non-alcohol based, mild non-abrasive detergent onto a clean, soft, lint-free cloth, then wipe the surface.

Disclaimer

- ViewSonic® does not recommend the use of any ammonia or alcohol-based cleaners on the display screen or case. Some chemical cleaners have been reported to damage the screen and/or case of the device.
- ViewSonic® will not be liable for damage resulting from use of any ammonia or alcohol-based cleaners.

NOTE: If condensation appears between the glass and the panel, keep the display turned on until the moisture disappears.

Regulatory and Service Information

Compliance Information

This section addresses all connected requirements and statements regarding regulations. Confirmed corresponding applications shall refer to nameplate labels and relevant markings on the unit.

FCC Compliance Statement

This device has been tested and found to comply with the limits for a Class A digital device, pursuant to Part 15 of the FCC Rules. These limits are designed to provide reasonable protection against harmful interference when the equipment is operated in a commercial environment. This equipment generates, uses, and can radiate radio frequency energy and, if not installed and used in accordance with the instruction manual, may cause harmful interference to radio communications. Operation of this equipment in a residential area is likely to cause harmful interference, in which case the user will be required to correct the interference at their own expense.

Properly shielded and grounded cables and connectors must be used in order to meet FCC emission limits. ViewSonic is not responsible for any radio or television interference caused by using other than recommended cables and connectors or by unauthorized changes or modifications to this equipment. Unauthorized changes or modifications could void the user's authority to operate the equipment.

This device complies with Part 15 of the FCC Rules. Operation is subject to the following two conditions: (1) this device may not cause harmful interference, and (2) this device must accept any interference received, including interference that might cause undesired operation.

Warning: You are cautioned that changes or modifications not expressly approved by the party responsible for compliance could void your authority to operate the equipment.

Industry Canada Statement

CAN ICES (B) / NMB (B)

CE Conformity for European Countries



The device complies with the EMC Directive 2014/30/EU and Low Voltage Directive 2014/35/EU.

The following information is only for EU-member states:

The mark shown to the right is in compliance with the Waste Electrical and Electronic Equipment Directive 2012/19/EU (WEEE). The mark indicates the requirement NOT to dispose of the equipment as unsorted municipal waste, but use the return and collection systems according to local law.



Declaration of RoHS2 Compliance

This product has been designed and manufactured in compliance with Directive 2011/65/EU of the European Parliament and the Council on restriction of the use of certain hazardous substances in electrical and electronic equipment (RoHS2 Directive) and is deemed to comply with the maximum concentration values issued by the European Technical Adaptation Committee (TAC) as shown below:

Substance	Proposed Maximum Concentration	Actual Concentration
Lead (Pb)	0.1%	< 0.1%
Mercury (Hg)	0.1%	< 0.1%
Cadmium (Cd)	0.01%	< 0.01%
Hexavalent Chromium (Cr6 ⁺)	0.1%	< 0.1%
Polybrominated biphenyls (PBB)	0.1%	< 0.1%
Polybrominated diphenyl ethers (PBDE)	0.1%	< 0.1%
Bis (2-ethylhexyl) phthalate (DEHP)	0.1%	< 0.1%
Butyl benzyl phthalate (BBP)	0.1%	< 0.1%
Dibutyl phthalate (DBP)	0.1%	< 0.1%
Diisobutyl phthalate (DIBP)	0.1%	< 0.1%

Certain components of products as stated above are exempted under the Annex III of the RoHS2 Directives as noted below:

- Copper alloy containing up to 4% lead by weight.
- Lead in high melting temperature type solders (i.e. lead-based alloys containing 85% by weight or more lead).
- Electrical and electronic components containing lead in a glass or ceramic other than dielectric ceramic in capacitors, e.g. piezoelectronic devices, or in a glass or ceramic matrix compound.
- Lead in dielectric ceramic in capacitors for a rated voltage of 125V AC or 250V DC or higher.

ENERGY STAR Statement

ENERGY STAR is a U.S. Environmental Protection Agency voluntary program that helps businesses and individuals save money and protect our climate through superior energy efficiency. Products that earn the ENERGY STAR prevent greenhouse gas emissions by meeting strict energy efficiency criteria or requirements set by the U.S. Environmental Protection Agency.

As an ENERGY STAR Partner, ViewSonic is determined to meet the Energy star Guidelines and mark all certified models with the ENERGY STAR logo.

The following logo appears on all ENERGY STAR-certified models:



NOTE: The power management features significantly reduce energy consumption when the product is not in use. Power management allows the device to automatically enter a low power “sleep” mode after a defined period of inactivity. And the power management features also enter Sleep Mode or Off Mode within 5 minutes of being disconnected from a host computer. Please note any change in energy settings will increase energy consumption.

Indian Restriction of Hazardous Substances

Restriction on Hazardous Substances statement (India). This product complies with the “India E-waste Rule 2011” and prohibits use of lead, mercury, hexavalent chromium, polybrominated biphenyls or polybrominated diphenyl ethers in concentrations exceeding 0.1 weight % and 0.01 weight % for cadmium, except for the exemptions set in Schedule 2 of the Rule.

Product Disposal at End of Product Life

ViewSonic® respects the environment and is committed to working and living green. Thank you for being part of Smarter, Greener Computing. Please visit the ViewSonic® website to learn more.

USA & Canada:

<https://www.viewsonic.com/us/go-green-with-viewsonic>

Europe:

<https://www.viewsonic.com/eu/environmental-social-governance/recycle>

Taiwan:

<https://recycle.moenv.gov.tw/>

For EU users, please contact us for any safety/accident issue experienced with this product:

ViewSonic Europe Limited



Haaksbergweg 75
1101 BR Amsterdam
Netherlands



+31 (0) 650608655



EPREL@viewsoniceurope.com



<https://www.viewsonic.com/eu/>

Copyright Information

Copyright© ViewSonic® Corporation, 2024. All rights reserved.

Macintosh and Power Macintosh are registered trademarks of Apple Inc.

Microsoft, Windows, and the Windows logo are registered trademarks of Microsoft Corporation in the United States and other countries.

ViewSonic® and the three birds logo are registered trademarks of ViewSonic® Corporation.

VESA is a registered trademark of the Video Electronics Standards Association. DPMS, DisplayPort, and DDC are trademarks of VESA.

ENERGY STAR® is a registered trademark of the U.S. Environmental Protection Agency (EPA).

As an ENERGY STAR® partner, ViewSonic® Corporation has determined that this product meets the ENERGY STAR® guidelines for energy efficiency.

Disclaimer: ViewSonic® Corporation shall not be liable for technical or editorial errors or omissions contained herein; nor for incidental or consequential damages resulting from furnishing this material, or the performance or use of this product.

In the interest of continuing product improvement, ViewSonic® Corporation reserves the right to change product specifications without notice. Information in this document may change without notice.

No part of this document may be copied, reproduced, or transmitted by any means, for any purpose without prior written permission from ViewSonic® Corporation.

Customer Service

For technical support or product service, see the table below or contact your reseller.

NOTE: You will need the product's serial number.

Country/ Region	Website	Country/ Region	Website
Asia Pacific & Africa			
Australia	www.viewsonic.com/au/	Bangladesh	www.viewsonic.com/bd/
中国 (China)	www.viewsonic.com.cn	香港 (繁體中文)	www.viewsonic.com/hk/
Hong Kong (English)	www.viewsonic.com/hk-en/	India	www.viewsonic.com/in/
Indonesia	www.viewsonic.com/id/	Israel	www.viewsonic.com/il/
日本 (Japan)	www.viewsonic.com/jp/	Korea	www.viewsonic.com/kr/
Malaysia	www.viewsonic.com/my/	Middle East	www.viewsonic.com/me/
Myanmar	www.viewsonic.com/mm/	Nepal	www.viewsonic.com/np/
New Zealand	www.viewsonic.com/nz/	Pakistan	www.viewsonic.com/pk/
Philippines	www.viewsonic.com/ph/	Singapore	www.viewsonic.com/sg/
臺灣 (Taiwan)	www.viewsonic.com/tw/	ประเทศไทย	www.viewsonic.com/th/
Việt Nam	www.viewsonic.com/vn/	South Africa & Mauritius	www.viewsonic.com/za/
Americas			
United States	www.viewsonic.com/us	Canada	www.viewsonic.com/us
Latin America	www.viewsonic.com/la		
Europe			
Europe	www.viewsonic.com/eu/	France	www.viewsonic.com/fr/
Deutschland	www.viewsonic.com/de/	Қазақстан	www.viewsonic.com/kz/
Россия	www.viewsonic.com/ru/	España	www.viewsonic.com/es/
Türkiye	www.viewsonic.com/tr/	Україна	www.viewsonic.com/ua/
United Kingdom	www.viewsonic.com/uk/		

Limited Warranty

ViewSonic® Smart White Board

What the warranty covers:

ViewSonic® warrants its products to be free from defects in material and workmanship during the warranty period. If a product proves to be defective in material or workmanship during the warranty period, ViewSonic® will, at its sole option, and as your sole remedy, repair or replace the product with a similar product. Replacement Product or parts may include remanufactured or refurbished parts or components. The repair or replacement unit or parts or components will be covered by the balance of the time remaining on the customer's original limited warranty and the warranty period will not be extended. ViewSonic® provides no warranty for any third-party software whether included with the product or installed by the customer, installation of any unauthorized hardware parts or components (e.g. Projector Lamps). (Please refer to: "What the warranty excludes and does not cover" section).

Who the warranty protects:

This warranty is valid only for the first consumer purchaser.

What the warranty excludes and does not cover:

- Any product on which the serial number has been defaced, modified, or removed.
- Damage, deterioration, or malfunction resulting from:
 - » Accident, misuse, neglect, fire, water, lightning, or other acts of nature, unauthorized product modification, or failure to follow instructions supplied with the product.
 - » Repair or attempted repair by anyone not authorized by ViewSonic®.
 - » Damage to or loss of any programs, data, or removable storage media.
 - » Normal wear and tear.
 - » Removal or installation of the product.
- Software or data loss occurring during repair or replacement.
- Any damage of the product due to shipment.
- Causes external to the product, such as electric power fluctuations or failure.
- Use of supplies or parts not meeting ViewSonic's specifications.
- Failure of owner to perform periodic product maintenance as stated in the User Guide.

- Any other cause which does not relate to a product defect.
- Damage caused by static (non-moving) images displayed for lengthy periods of time (also referred to as image burn-in).
- Software - Any third-party software included with the product or installed by the customer.
- Hardware/Accessories/Parts/Components – Installation of any unauthorized hardware, accessories, consumable parts or components (e.g. Projector Lamps).
- Damage to, or abuse of, the coating on the surface of the display through inappropriate cleaning as described in the product User Guide.
- Removal, installation, and set-up service charges, including wall-mounting of the product.

How to get service:

- For information about receiving service under warranty, contact ViewSonic® Customer Support (Please refer to the “Customer Service” page). You will need to provide your product’s serial number.
- To obtain warranty service, you will be required to provide: (a) the original dated sales slip, (b) your name, (c) your address, (d) a description of the problem, and (e) the serial number of the product.
- Take or ship the product, freight prepaid, in the original container to an authorized ViewSonic® service center or ViewSonic®.
- For additional information or the name of the nearest ViewSonic® service center, contact ViewSonic®.

Limitation of implied warranties:

There are no warranties, express or implied, which extend beyond the description contained herein including the implied warranty of merchantability and fitness for a particular purpose.

Exclusion of damages:

ViewSonic's liability is limited to the cost of repair or replacement of the product. ViewSonic® shall not be liable for:

- Damage to other property caused by any defects in the product, damages based upon inconvenience, loss of use of the product, loss of time, loss of profits, loss of business opportunity, loss of goodwill, interference with business relationships, or other commercial loss, even if advised of the possibility of such damages.
- Any other damages, whether incidental, consequential or otherwise.
- Any claim against the customer by any other party.
- Repair or attempted repair by anyone not authorized by ViewSonic®.

Effect of state law:

This warranty gives you specific legal rights, and you may also have other rights which vary from state to state. Some states do not allow limitations on implied warranties and/or do not allow the exclusion of incidental or consequential damages, so the above limitations and exclusions may not apply to you.

Sales outside the U.S.A. and Canada:

For warranty information and service on ViewSonic® products sold outside of the U.S.A. and Canada, contact ViewSonic® or your local ViewSonic® dealer.

The warranty period for this product in mainland China (Hong Kong, Macao, and Taiwan Excluded) is subject to the terms and conditions of the Maintenance Guarantee Card.

For users in Europe and Russia, full details of warranty provided can be found at: <http://www.viewsonic.com/eu/> under "Support/Warranty Information".

Mexico Limited Warranty

ViewSonic® Smart White Board

What the warranty covers:

ViewSonic® warrants its products to be free from defects in material and workmanship, under normal use, during the warranty period. If a product proves to be defective in material or workmanship during the warranty period, ViewSonic® will, at its sole option, repair or replace the product with a like product. Replacement product or parts may include remanufactured or refurbished parts or components & accessories.

Who the warranty protects:

This warranty is valid only for the first consumer purchaser.

What the warranty excludes and does not cover:

- Any product on which the serial number has been defaced, modified or removed.
- Damage, deterioration, or malfunction resulting from:
 - » Accident, misuse, neglect, fire, water, lightning, or other acts of nature, unauthorized product modification, unauthorized attempted repair, or failure to follow instructions supplied with the product.
 - » Causes external to the product, such as electrical power fluctuations or failure.
 - » Use of supplies or parts not meeting ViewSonic®'s specifications.
 - » Normal wear and tear.
 - » Any other cause which does not relate to a product defect.
- Any product exhibiting a condition commonly known as “image burn-in” which results when a static image is displayed on the product for an extended period of time.
- Removal, installation, insurance, and set-up service charges.

How to get service:

For information about receiving service under warranty, contact ViewSonic® Customer Support (Please refer to the attached “Customer Service” page). You will need to provide your product’s serial number, so please record the product information in the space provided below on your purchase for your future use. Please retain your receipt of proof of purchase to support your warranty claim.

For Your Records

Product Name: _____ Model Number: _____
Document Number: _____ Serial Number: _____
Purchase Date: _____ Extended Warranty Purchase? _____(Y/N)
If so, what date does warranty expire? _____

- To obtain warranty service, you will be required to provide (a) the original dated sales slip, (b) your name, (c) your address, (d) a description of the problem, and (e) the serial number of the product.
- Take or ship the product, in the original container packaging, to an authorized ViewSonic® service center.
- Round trip transportation costs for in-warranty products will be paid by ViewSonic®.

Limitation of implied warranties:

There are no warranties, express or implied, which extend beyond the description contained herein including the implied warranty of merchantability and fitness for a particular purpose.

Exclusion of damages:

ViewSonic®’s liability is limited to the cost of repair or replacement of the product. ViewSonic® shall not be liable for:

- Damage to other property caused by any defects in the product, damages based upon inconvenience, loss of use of the product, loss of time, loss of profits, loss of business opportunity, loss of goodwill, interference with business relationships, or other commercial loss, even if advised of the possibility of such damages.
- Any other damages, whether incidental, consequential or otherwise.
- Any claim against the customer by any other party.
- Repair or attempted repair by anyone not authorized by ViewSonic®.

Contact Information for Sales & Authorized Service (Centro Autorizado de Servicio) within Mexico:	
Name, address, of manufacturer and importers: México, Av. de la Palma #8 Piso 2 Despacho 203, Corporativo Interpalmas, Col. San Fernando Huixquilucan, Estado de México Tel: (55) 3605-1099 http://www.viewsonic.com/la/soporte/index.htm	
NÚMERO GRATIS DE ASISTENCIA TÉCNICA PARA TODO MÉXICO: 001.866.823.2004	
Hermosillo: Distribuciones y Servicios Computacionales SA de CV. Calle Juarez 284 local 2 Col. Bugambilias C.P: 83140 Tel: 01-66-22-14-9005 E-Mail: disc2@hmo.megared.net.mx	Villahermosa: Compumantenimientos Garantizados, S.A. de C.V. AV. GREGORIO MENDEZ #1504 COL, FLORIDA C.P. 86040 Tel: 01 (993) 3 52 00 47 / 3522074 / 3 52 20 09 E-Mail: compumantenimientos@prodigy.net.mx
Puebla, Pue. (Matriz): RENTA Y DATOS, S.A. DE C.V. Domicilio: 29 SUR 721 COL. LA PAZ 72160 PUEBLA, PUE. Tel: 01(52).222.891.55.77 CON 10 LINEAS E-Mail: datos@puebla.megared.net.mx	Veracruz, Ver.: CONEXION Y DESARROLLO, S.A DE C.V. Av. Americas # 419 ENTRE PINZÓN Y ALVARADO Fracc. Reforma C.P. 91919 Tel: 01-22-91-00-31-67 E-Mail: gacosta@qplus.com.mx
Chihuahua: Soluciones Globales en Computación C. Magisterio # 3321 Col. Magisterial Chihuahua, Chih. Tel: 4136954 E-Mail: Cefeo@soluglobales.com	Cuernavaca: Compusupport de Cuernavaca SA de CV Francisco Leyva # 178 Col. Miguel Hidalgo C.P. 62040, Cuernavaca Morelos Tel: 01 777 3180579 / 01 777 3124014 E-Mail: aquevedo@compusupportcva.com
Distrito Federal: QPLUS, S.A. de C.V. Av. Coyoacán 931 Col. Del Valle 03100, México, D.F. Tel: 01(52)55-50-00-27-35 E-Mail : gacosta@qplus.com.mx	Guadalajara, Jal.: SERVICRECE, S.A. de C.V. Av. Niños Héroes # 2281 Col. Arcos Sur, Sector Juárez 44170, Guadalajara, Jalisco Tel: 01(52)33-36-15-15-43 E-Mail: mmiranda@servicrece.com
Guerrero Acapulco: GS Computación (Grupo Sesicomp) Progreso #6-A, Colo Centro 39300 Acapulco, Guerrero Tel: 744-48-32627	Monterrey: Global Product Services Mar Caribe # 1987, Esquina con Golfo Pérsico Fracc. Bernardo Reyes, CP 64280 Monterrey N.L. México Tel: 8129-5103 E-Mail: aydeem@gps1.com.mx
MERIDA: ELECTROSER Av Reforma No. 403Gx39 y 41 Mérida, Yucatán, México CP97000 Tel: (52) 999-925-1916 E-Mail: rrrb@sureste.com	Oaxaca, Oax.: CENTRO DE DISTRIBUCION Y SERVICIO, S.A. de C.V. Murguía # 708 P.A., Col. Centro, 68000, Oaxaca Tel: 01(52)95-15-15-22-22 Fax: 01(52)95-15-13-67-00 E-Mail: gpotai2001@hotmail.com
Tijuana: STD Av Ferrocarril Sonora #3780 L-C Col 20 de Noviembr Tijuana, Mexico	FOR USA SUPPORT: ViewSonic® Corporation 381 Brea Canyon Road, Walnut, CA. 91789 USA Tel: 800-688-6688 E-Mail: http://www.viewsonic.com



ViewSonic®